

Wisconsin Weatherization Field Guide

2023



Foreword

The Wisconsin Weatherization Field Guide is a comprehensive guide to installing weatherization measures and verifying the quality of the work. The Field Guide is a tool for crew workers, energy auditors, and inspectors. The program's policies and administrative practices are identified in the Wisconsin Weatherization Program Manual.

The Field Guide started with dedicated weatherization crew workers determined to improve their trade and the services provided to their customers. It evolved from there to documenting those practices to share them with the rest of the weatherization network. The original Wisconsin Weatherization Field Guide was produced through a collaboration of the 2005 Weatherization Technical Advisory Group, Slipstream (*formerly Wisconsin Energy Conservation Corporation (WECC)*), and Saturn Resource Management.

Wisconsin is one of the national leaders in the Weatherization Assistance Program, and this guide represents the ongoing effort to continually improve our practices and procedures to deliver the best product to our customers.

Credits

Copyright 2005; 2007; 2014; 2015; 2016; 2018; 2019; 2020; 2021; and 2022 – Saturn Resource Management; Slipstream; State of Wisconsin, Department of Administration, Division of Energy, Housing and Community Resources.

Information in *Chapter 5 – Sections 5.15.1, 5.15.2, 5.15.3, 5.15.4, and 5.15.5* is used with permission from *the WAP Precautionary Radon Mitigation Field Guide* by Dick Kornbluth, Dick Kornbluth, LLC, Copyright 2018, Section 11 – Sumps; Pages – 18-22.

The original document was developed in 2005 through collaboration between Wisconsin Division of Energy Services, Slipstream (*formerly Wisconsin Energy Conservation Corporation (WECC)*), Saturn Resource Management, the Technical Assistance Group (TAG) and various technical consultants.



Contents

Chapter 1: Diagnosing and Sealing Air Leakage	1
1.1 Air Leakage Diagnostics Policy.....	1
1.2 Diagnostic Overview	1
1.2.1 Air Leakage Effects.....	1
1.2.2 Goals of Air Leakage Testing.....	2
1.3 House Airtightness Testing.....	3
1.3.1 Blower Door Terminology.....	4
1.3.2 Preparing for a Blower Door Test.....	5
1.3.3 Blower Door Test Procedures	6
1.4 Air Sealing and Indoor Air Quality	7
1.4.1 Air Sealing.....	8
1.5 Zone Pressure Diagnostics.....	10
1.5.1 Simple Air Leakage Tests	13
1.5.2 Using a Digital Gauge to Test Pressure Boundaries.....	14
1.5.3 Locating the Pressure/Thermal Boundary	19
1.5.4 Add-A-Hole Zone Leakage Measurement	21
1.5.5 Open-A-Door Zone Leakage Measurement.....	24
1.5.6 Adjusting Zone Pressure Measurements for Baseline.....	26
Final Inspection and Quality Assurance Standards	28
Chapter 2: Heating Envelope Building Measures	1
2.1 Heating Envelope Insulation	1
2.2 Attic and Roof Insulation	1
2.2.1 Pre-insulation Attic and Roof Insulation Prep.....	1
2.2.2 Attic Ventilation.....	3
2.2.3 Attic Accesses, Walk-up Stairways, and Doors Attic Accesses	4
2.2.4 Calculating Attic Loose-Fill Insulation	5
2.2.5 Installing Blown-in Attic Insulation	5
2.2.6 Installing Attic Batt Insulation	6
2.2.7 Installing Attic Insulation in 1½ Story Homes (Finished Attics)	6
2.2.8 Insulating Attics with Limited Accessibility	10
2.2.9 Insulating Closed Roof Cavities	10
2.3 Wall Insulation	11
2.3.1 Calculating Wall Coverage and Density.....	12
2.3.2 Inspecting and Repairing Walls Before Installing Insulation	12
2.3.3 Removing Siding and Drilling Sheathing.....	13
2.3.4 Dense-Packed Wall Insulation from the Exterior.....	14
2.3.5 Dense-Packed Wall Insulation from the Interior.....	15
2.3.6 Dense-Packing from Other Access Locations.....	15
2.3.7 Interior Open-Cavity Wall Insulation	16
2.4 Crawl Space Requirements	16
2.4.1 Crawl Space Access Requirements	17

2.4.2 Crawl Space Signage	17
2.5 Floor and Foundation Insulation	17
2.5.1 Establishing a Thermal Boundary.....	18
2.5.2 Rim Joist and Box Sill Insulation	18
2.5.3 Floor Insulation	19
2.5.4 Foundation Insulation.....	20
Final Inspection and Quality Assurance Standards	23
Chapter 3: Heating System Measures.....	1
3.1 Heating and Cooling Systems.....	1
3.2 General Heating System Replacement	1
3.3 Forced-Air Furnace Replacement	2
3.4 Forced-Air Furnace Air Distribution	2
3.4.1 Duct System Modification.....	2
3.4.2 Duct Leakage	3
3.4.3 Duct Insulation.....	5
3.4.4 Measuring System Air Flow	5
3.4.5 Measuring Temperature Rise.....	8
3.4.6 Filters	8
3.5 Boiler Replacement.....	10
3.5.1 High-Efficiency (≥ 90%+) Boilers.....	11
3.6 Hydronic Distribution Systems	12
3.7 Boiler Efficiency and Maintenance	13
3.8 Gas-Fired Heating Systems.....	15
3.8.1 Gas-Fired Heating System Installation	15
3.8.2 Condensate Removal	16
3.8.3 Testing and Servicing Gas-Fired Systems.....	17
3.8.4 Leak-Testing Gas Piping.....	24
3.9 Oil-Fired Heating Systems.....	24
3.9.1 Oil-Fired Heating System Installation	24
3.9.2 Testing and Servicing Oil-Fired Systems.....	24
3.10 Electric Furnaces and Electric Baseboard Heat.....	27
3.10.1 Cold-Climate Air-Source Heat Pump Installations.....	28
3.11 Cooling Systems	28
3.11.1 Central Air Conditioner Installations	29
3.11.2 Room/Window Air Conditioner Installations	29
3.11.3 Air-Source Heat Pump Installations.....	30
3.12 Replacing Space Heaters.....	31
3.13 Replacing Wood Stoves	31
3.14 Venting Combustion Gases.....	32
3.14.1 Improving Inadequate Draft.....	32
3.15 Combustion Air	34
3.15.1 Unconfined Space Combustion Air.....	34
3.15.2 Confined Space Combustion Air.....	35

3.15.3	Net-Free Area.....	35
3.15.4	Sizing Combustion-Air Openings.....	36
3.16	Thermostats	37
3.16.1	Programmable and Smart Thermostats.....	37
	Final Inspection and Quality Assurance Standards	38
	Chapter 4: Base Load Measures.....	1
4.1	Water Heater Replacement	1
4.1.1	Gas Water Heater Installations	2
4.1.2	Electric Water Heater Installations	2
4.2	Domestic Hot Water Treatments.....	3
4.2.1	Water Saving Showerheads and Aerators.....	3
4.2.2	Water Heater Pipe Insulation	3
4.2.3	Setting or Reducing Water Temperature	3
4.3	Refrigerator or Freezer Replacement and Removal.....	4
4.4	Lighting	4
4.5	Clothes Washer	5
	Final Inspection and Quality Assurance Standards	7
	Chapter 5: Health and Safety	1
5.1	Personal Protective Equipment.....	1
5.2	Safety Data Sheet (SDS).....	2
5.3	Confined Spaces	2
5.4	Source Pollutant Control	2
5.4.1	Carbon Monoxide (CO).....	3
5.4.2	Carbon Monoxide (CO) Alarms	3
5.4.3	Smoke Alarms	4
5.4.4	Moisture Problems.....	5
5.4.5	Foundation Moisture Control.....	6
5.5	Lead Paint and Lead-Safe Work.....	7
5.6	Asbestos	9
5.7	Electrical Safety.....	9
5.8	Combustion Appliance and Fuel Distribution Safety.....	10
5.8.1	Gas Piping Inspection.....	10
5.8.2	Ambient CO Monitoring.....	11
5.8.3	Combustion Appliance Safety Inspection	12
5.9	Measuring Natural Draft	16
5.10	Depressurization Guidance	17
5.10.1	Make-Up Air Systems	17
5.11	Water Heater Replacement	18
5.12	Mechanical Ventilation	18
5.12.1	Choosing Ventilation Systems.....	18
5.12.2	Sizing Ventilation Systems.....	19
5.12.3	Local Exhaust Fans	19
5.12.4	Whole-Building Exhaust-Only Ventilation.....	20

5.12.5	Exhaust Fan Ducting.....	20
5.12.6	Supply Ventilation Systems.....	21
5.12.7	Balanced Ventilation Systems.....	22
5.12.8	Heat-Recovery Ventilators	27
5.12.9	Heat-Recovery Ventilator (HRV) and Energy-Recovery Ventilator (ERV) Installation....	27
5.12.10	Ventilation Control Strategies.....	27
5.13	Dryer Venting.....	28
5.14	Priorities for Existing Homes.....	29
5.14.1	Installation Best Practices	30
5.15	Radon	30
5.15.1	Sumps.....	30
5.15.2	Sump Pumps.....	31
5.15.3	Sump covers for submersible pumps	31
5.15.4	Sump covers for pedestal pumps.....	32
5.15.5	Floor Drains.....	33
	Final Inspection and Quality Assurance Standards	34
	Chapter 6: Repair	1
6.1	Windows and Doors.....	1
6.1.1	Window Repair and Replacement.....	1
6.1.2	Door Repair and Replacement.....	2
	Final Inspection and Quality Assurance Standards	4
	Chapter 7: Manufactured Home Weatherization	1
7.1	Manufactured Home Weatherization.....	1
7.2	Supply Distribution System.....	2
7.2.1	Pressure Pan Duct Testing	2
7.2.2	Interpreting Duct Leakage Results	3
7.2.3	Manufactured Home Duct Sealing.....	3
7.3	Return-Air Distribution System.....	5
7.3.1	Measuring Temperature Rise.....	6
7.3.2	Measuring Room Pressure Differences.....	6
7.4	Floor/Belly Insulation.....	7
7.4.1	Preparations for Belly Insulation.....	7
7.4.2	Insulating the Belly from Underneath.....	8
7.4.3	Rim Blow through Rim Joists	9
7.4.4	Wing Blow	10
7.5	Attic/Ceiling Insulation.....	10
7.5.1	Preparing for Ceiling Insulation	10
7.5.2	Blowing the Roof Cavity from the Roof Blowing from a Square Hole	11
7.5.3	Blowing the Roof Cavity through Round Holes	11
7.5.4	Blowing a Pitched Roof.....	11
7.5.5	Blowing the Roof Cavity from the Edge	11
7.5.6	Interior Drill and Blow.....	12
7.6	Sidewall Insulation	12

7.6.1	Preparing Siding for Wall Insulation.....	13
7.6.2	Sidewall Blowing Technique	13
7.6.3	Sidewall Stuffing Technique.....	13
7.7	Air Sealing.....	14
7.8	Combustion Appliance and Fuel Distribution Safety.....	14
7.9	Heating Unit Replacement.....	14
7.10	Water Heater Replacement	15
7.10.1	Gas Water Heater Installations.....	15
7.10.2	Exterior Access Water Heater Closets.....	15
7.11	Repair	16
7.12	Window Replacement	16
7.13	Interior Storm Windows	16
7.14	Door Replacement.....	16
	Final Inspection and Quality Assurance Standards	18
	APPENDICES	1
A-1:	Glossary.....	2
A-2:	R-Values for Common Materials.....	7
A-3:	Insulation Density and Bag Count Calculations	8
A-4:	General Information on Spray Polyurethane Foam (SPF)	13

Chapter 1: Diagnosing and Sealing Air Leakage

1.1 Air Leakage Diagnostics Policy

Blower door testing is required on all buildings (except for mobile homes weatherized using the Mobile Home Measures List) before weatherization is started (“As-Is” test), and upon completion of all measures that effect building tightness (“Final” test). Conduct a pressurization test when hazards (such as friable asbestos, vermiculite insulation that may contain asbestos, mold, or excessive, unmanaged pet waste) exist in the building. Follow the air sealing protocol to complete air sealing measures on the building in *Chapter 1 – Section 1.4.1*. Always perform Zone Pressure Diagnostics testing on buildings with an attached garage. Document the results of air leakage diagnostic testing in the Diagnostic Workbook. Take corrective action when air sealing activities have contributed to a safety hazard or an indoor air quality issue, such as adding necessary ventilation or ensuring there is no spillage for natural drafting appliances under greatest depressurization achievable (GDA) conditions.

1.2 Diagnostic Overview

The testing described here will help to analyze the existing air barriers and decide whether and where air sealing is needed.

Air barrier materials in a building form the building’s **pressure boundary**, while insulation materials form the building’s **thermal boundary**. The location and condition of these barriers have a substantial effect on the insulation’s effectiveness. Optimal energy savings and minimal heat loss are achieved when the two systems are continuous and aligned in direct contact with each other with the air barrier positioned between the conditioned space and the insulation materials.

1.2.1 Air Leakage Effects

Controlling shell air leakage is a key to a successful weatherization job. Decisions made about sealing air leaks will affect a building throughout its lifetime. The following list highlights important ways air leakage affects buildings.

1. Air leakage can significantly change the net heat loss through a framing cavity.
2. Air leakage typically accounts for a significant percentage of a building’s heat loss.
3. Air leakage can carry moisture into and out of the house, affecting the relative humidity indoors, potentially creating mold and moisture problems.
4. The location and amount of air leakage can affect the draft of natural-draft combustion appliances or fireplaces.
5. Air leakage provides ventilation for exhausting pollutants and admitting fresh air.
However, air leaks can bring pollutants into the home as easily as they can expel them.

Building height and location, weather, and mechanical equipment affect air leakage in buildings. Strong winds may create a positive pressure on one side of a building, and a negative pressure

on the opposite side. A forced-air distribution system, a chimney, or an exhaust fan may create a negative pressure in the building. Often air moves through a conditioned building as if the building is a chimney or smokestack. Unconditioned air enters low in the building (infiltration) and conditioned air exits at the top of the building (exfiltration). This is called the **stack effect**. The area between the air coming in at the bottom (infiltration) and the air leaving the building at the top (exfiltration) is called the **neutral pressure plane**. Not much air leakage comes in or goes out at the neutral pressure plane. As the building is tightened at the bottom, the neutral pressure plane moves upward in the building. As the building is tightened at the top, the neutral pressure plane moves downward. For the best results, seal at both the top and bottom of the building.

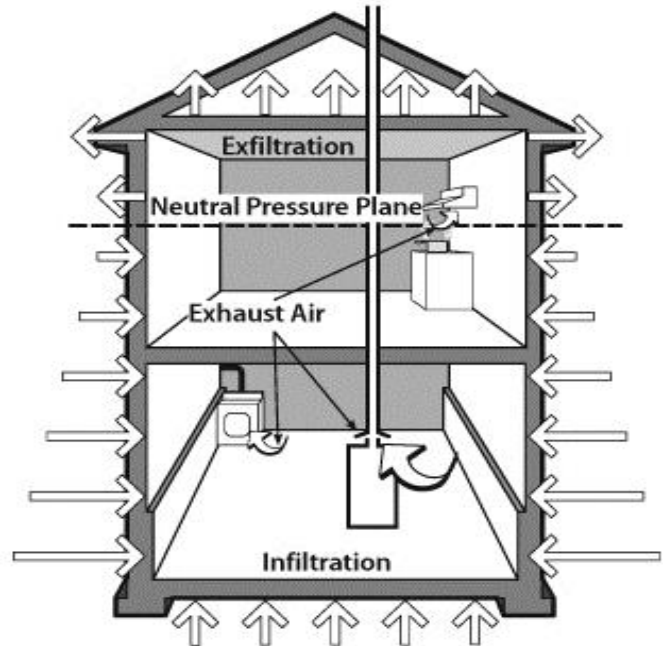

Air leakage concepts: When performing air sealing, it helps to understand the effects of exhaust appliances, the stack effect, and wind effect.

Air sealing may affect the natural draft of combustion appliances that are connected to a non-positive venting system. After all weatherization measures are completed, greatest depressurization achievable and spillage testing must be done on all buildings that contain natural-draft combustion appliances or fireplaces. The exception is that spillage testing cannot be completed on wood heating systems or when the design of the appliance is not conducive to testing for spillage. See *Greatest Depressurization Achievable in Chapter 5 – Section 5.8.3*. Additional depressurization information for wood heating systems can be found in *Section 5.10*.

1.2.2 Goals of Air Leakage Testing

Air leakage tests are the tools used to determine the location and amount of air leakage through a building's pressure boundary. Accurate tests allow fast, effective air sealing of the pressure boundary, while at the same time safeguarding indoor air quality.

A secondary goal of air leakage testing is to decide where to locate the air barrier when an intermediate zone, like an attic or crawl space, provides a choice of air-barrier locations. The ceiling is usually the thermal boundary of a building, for example, rather than the roof. However, at the foundation, the air barrier may be located at the first-floor deck or at the foundation wall. Air leakage testing helps establish the best, fastest, or least expensive place to locate a functioning air barrier. Whenever possible, locate the air barrier to include plumbing and the air distribution system inside the pressure boundary. In most buildings, the air barrier can be located at the concrete/block foundation wall. In a building with a rubble foundation, the floor deck may be the best place to complete a functional air barrier, especially if limited (or no) air distribution or plumbing is in the area. If plumbing is isolated outside the thermal boundary, take precautions to prevent pipes from freezing.

Air leakage testing is needed because there simply is no accurate prescriptive method for determining the severity and location of leaks. Varying levels of testing may need to be performed to assess shell leakage. A simple blower door test may be sufficient for a simple home. Work can be completed more efficiently in complex buildings when zone pressure tests and infrared diagnostic tests provide added information.

*Where is the primary air barrier:
at the rafter or ceiling joist?*

*Are the intermediate
zones connected?*

*Are the floor cavities
connected to outdoors?*

*Do ducts supply heated
air to the addition?*

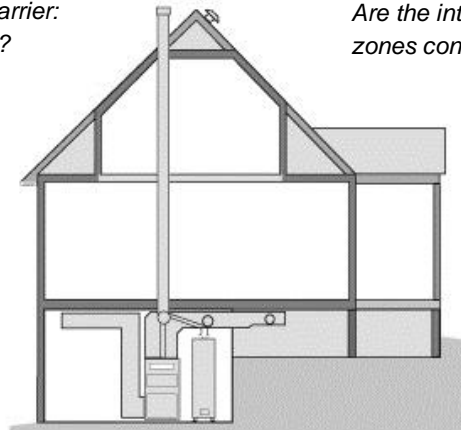

*Is the half-basement inside or
outside the air barrier? Is it
heated?*

*Are the crawl space ducts
inside or outside the air
barrier?*

Questions to ask and answer before air sealing: Your answers help determine the most efficient and cost-effective location for the air barrier.

It is most efficient and cost-effective to seal the large air leaks first. Chasing small leaks consumes time and is not usually cost-effective. Refer to the “Air Sealing Protocol” worksheet in the Diagnostic Workbook for guidance about air sealing protocol.

1.3 House Airtightness Testing

The blower door measures a home’s leakage rate at a standard pressure difference of 50 pascals. This leakage measurement can be used to compare air leakage rates before and after air sealing. The blower door also allows the technician to test parts of the home’s air barrier to locate air leaks. Sometimes air leaks are obvious. More often, the leaks are hidden, and the technician uses the blower door to obtain clues about their location.

This section outlines the basics of blower door air leakage measurement along with some techniques for gathering clues about the location of air leaks.

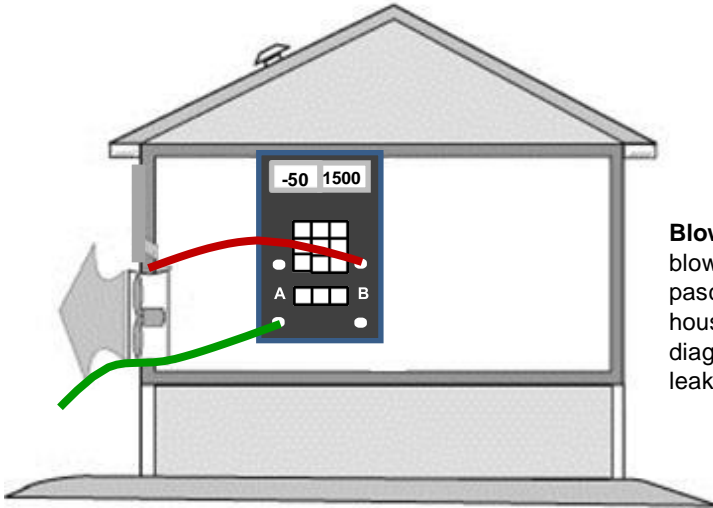

Blower door test: Air barriers are tested during a blower door test, with the house at a pressure of 50 pascals negative with reference to outdoors. This house has 1,500 CFM50 of air leakage. Further diagnostic tests can help determine where the leakage is coming from.

1.3.1 Blower Door Terminology

The blower door creates a 50-pascal pressure difference across the building shell and measures air flow in cubic feet per minute at 50 pascals. This provides an objective measure of the leakiness of a building. The blower door also creates pressure differences between rooms in the house and intermediate zones like attics, crawl spaces, and garages. Measuring these pressure differences can give clues about the location and size of a home's hidden air leaks.

The blower door components include the frame, panel, fan, and digital gauge.

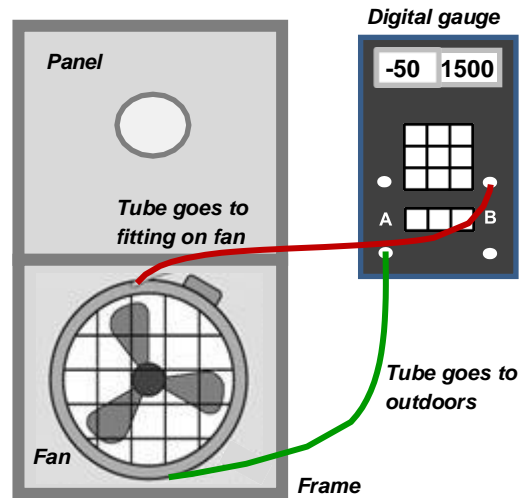

Digital gauges: Used to diagnose house and duct pressures quickly and accurately.

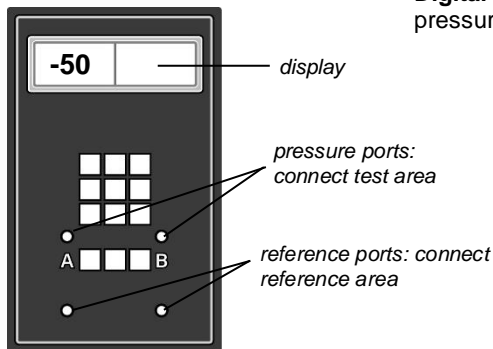

TEC DG-700
Pressure and Flow Gauge

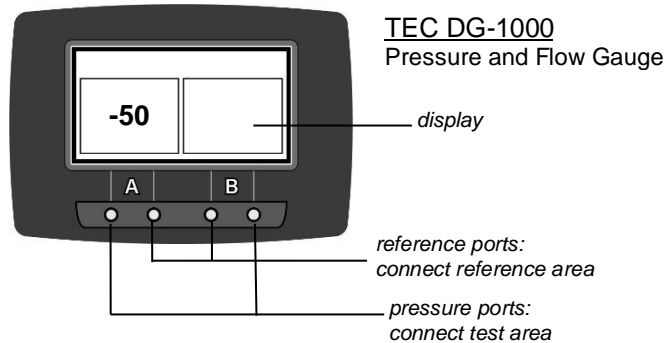

TEC DG-1000
Pressure and Flow Gauge

Connecting the digital gauge's hoses correctly is essential for accurate testing. There is an accepted method for communicating correct hose connections that helps avoid confusion.

This method uses the phrase "with reference to" (WRT) to distinguish between the input zone and reference zone for a particular pressure measurement. The outdoors is the most commonly used reference zone for blower door testing. The reference zone is considered the zero point on the pressure scale.

For example, "*House WRT Outside = -50 pascals*" means the house (Input) is 50 pascals negative compared with the outdoors (reference or zero-point). This pressure reading is called the house-to-outdoors pressure difference.

During the blower door test, the digital gauge measures the air flow pressure through the fan and the size of the fan opening to calculate the air leakage of the building. For the digital gauge to calculate the building's air leakage accurately, the air must be flowing at an adequate pressure through the fan. Tighter buildings may not have enough air leakage to create an adequate pressure for the air flow through an open fan. When the air pressure is too low through the fan, the digital gauge will indicate insufficient air flow by flashing "LO/LOW".

To increase fan pressure and air flow, use the flow rings commonly provided with the blower door, to reduce the fan's opening and increase pressure of the air flow through the fan. After attaching the flow ring(s), follow the manufacturer's instructions for selecting the proper setting on the digital gauge.

1.3.2 Preparing for a Blower Door Test

Preparing the house for a blower door test involves placing the house in "winter condition". Interior doors should be open to **all** conditioned areas (e.g., conditioned knee wall spaces, conditioned crawl spaces, etc.), while all exterior doors and windows including all storms, as well as accesses to unconditioned spaces, are closed. These conditions must be maintained for the duration of the test.

Try to anticipate problems the blower door test could cause. When a blower door test is being completed in depressurization mode, it can cause flame rollout and back drafting in combustion appliances, as well as debris being drawn out of fireplaces, opening unlatched attic access doors or ceiling tiles to be sucked down.

Follow these steps when preparing for a blower door test:

1. Identify the location of the pressure boundary.
2. Open interior doors to connect all conditioned areas of the house.
3. Close all exterior doors and windows including storms.
4. Survey outside air and intermediate zones for possible pollutants that may be drawn into the home during a blower door test. Test in pressurization mode if necessary.

5. Turn off combustion appliances connected to negative pressure venting systems— but do not forget to turn them back on after completing the test. **Tip:** Leaving vehicle keys next to or on an appliance that has been turned off, prevents departure without turning the appliance back on.
6. Close all fireplace and stove dampers. When the dwelling has an open-hearth fireplace, verify hot ashes/coins will not be blown out of the hearth, or complete test in pressurization mode. Proceed with caution when pressurizing to ensure that you do not stoke the fire in the fireplace with the added combustion air.

1.3.3 Blower Door Test Procedures

Follow this general procedure when performing a blower door test:

1. Install blower door frame, panel, and fan in an exterior doorway with a clear path to the outdoors and indoors. On windy days, try to place the fan parallel to the wind direction. FOR PRESSURIZATION TEST ONLY: Install the blower door fan with the inlet side facing outdoors (flow rings to the outside), so the fan is moving air from outdoors to indoors. Do not use the fan switch to reverse direction of air flow.
2. Place the digital gauge on the support bracket attached to the blower door frame or house door. Turn gauge on prior to placing any hoses on taps.
3. Connect a hose to the reference tap of Channel A on the digital gauge. Run this hose outdoors, at least 5 feet to the side of the fan, and ensure the end of the hose is protected from the wind.
4. FOR PRESSURIZATION TEST ONLY: Connect an additional hose to the reference tap of Channel B. Run this hose outdoors with the end of the hose located next to the side of the fan.
5. Connect a hose to the Input tap of Channel B on the digital gauge. Connect the other end of this hose to the pressure tap on the blower door fan.
6. Set up the digital gauge mode to measure air flow at 50 pascals (“PR/FL@50”). Select a configuration setting to match the flow ring installed on the blower door fan.

7. To obtain accurate blower door measurements, readings must be adjusted for wind and stack effect. This adjustment is also referred to as “adjusting for the baseline.” Use the “baseline” feature of the digital gauge to adjust for the baseline. Cover the fan opening, run the baseline function for 20 to 30 seconds, then press “enter” to accept the baseline reading. On windy days, allow the baseline function to record for 60 seconds or longer.

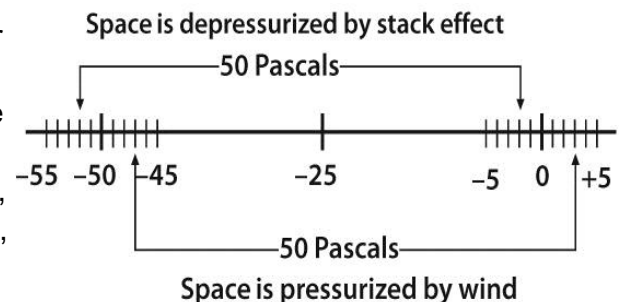

8. Remove flow rings as needed. Confirm the digital gauge’s mode is still pressure flow at 50 pascals (mode is set to “PR/FL@50”). Also, confirm the gauge’s configuration setting matches the flow ring(s) installed on the blower door fan.

9. Turn on the blower fan to begin the test and manually adjust the fan speed using the controller. Gradually increase the fan speed by slowly turning the fan controller clockwise. As the fan speed increases, the pressure reading displayed on Channel A should also increase. Continue to increase the fan speed until the pressure reading on Channel A is between 45 and 55 pascals. *See the manufacturer's blower door manual for information on testing using the "cruise control" feature.*
10. If the air speed through the fan is too low, the Channel B display will flash "LO/LOW". Install one or more rings and change the configuration setting on the gauge to measure and display an accurate flow measurement on Channel B of the digital gauge.
11. Adjust the "time average" setting to 5 seconds after reaching 50 pascals of pressure difference. On windy days, use a time average setting of 10 seconds, or long term.
12. **CAN'T REACH FIFTY** – If the building is extremely leaky, reaching a pressure difference of at least 45 pascals with the fan open may not be obtainable. Testing can still be completed, and as long as the gauge is in the PR/FL@50 mode, a CFM₅₀ leakage estimate will automatically be displayed on Channel B.
13. Document the CFM₅₀ from Channel B of the digital gauge in the Diagnostic Workbook. Measure the inside and outside temperatures and record in the Diagnostic Workbook.

Blower Door Test Follow-up

1. Return the house to its original condition.
2. Inspect combustion appliance pilot lights to ensure blower door testing did not extinguish them.
3. Reset thermostats of heaters and water heaters that were turned down for testing.
4. Document any unusual conditions affecting the blower door test and location where the blower door was set up. Photo document the test if needed.

1.4 Air Sealing and Indoor Air Quality

Air sealing affects the home's indoor air quality by reducing the amount of natural ventilation. When natural ventilation is reduced below a certain level, mechanical exhaust ventilation is sometimes needed to ensure pollutants are exhausted to the outside and enough fresh air is brought into the building.

For instructions on how to calculate the whole-house ventilation requirement, refer to the Diagnostic Workbook. Whenever feasible, install 100 percent of the required mechanical ventilation rate.

See *Mechanical Ventilation in Chapter 5 – Section 5.12* for more information about ventilation requirements.

1.4.1 Air Sealing

Complete air sealing work in a reasonable and cost-effective manner. The first blower door test (As-Is test) documents the overall leakiness of the building before weatherization work begins. It helps crews determine the potential for air sealing work to be completed. To identify what air sealing should be completed and where, use the blower door along with an infrared camera, smoke, or “feel” with your hands to locate air leaks. Another tool to help guide air sealing is zone pressure diagnostics. See *Zone Pressure Diagnostics (ZPD) in Chapter 1 – Section 1.5* for instructions regarding the use of zone pressure testing to guide air sealing.

Major air sealing is completed on the building along with or prior to installing any other shell measures. It includes installing window glass where missing, sealing gross holes in the building envelope, sealing construction key junctures, and sealing all major attic bypasses.

For gaps larger than ¼", use caulking, steel wool, or other pest-proof material to fill the penetration before sealing. If a span is greater than 24 inches, install support spans that are rated to span such distance under the existing (if not insulating) or prescribed load (if adding insulation). Penetrations shall be sealed with a durable material with a minimum expected service life of 10 years.

Minor air sealing is air sealing that occurs after the completion of major air sealing and all shell measures and is limited to 1 labor hour. The decision to complete minor air sealing shall be determined by the crew leader. Often, minor air sealing has a minimal impact on energy savings but can improve occupant comfort. Minor air sealing may include window and door weather-stripping, door sweeps, window air sealing, and caulking around trim.

Common air barrier flaws requiring air sealing include, but are not limited to:

Attics and Other Concealed Spaces

1. **Interior dropped soffits:** Cap the soffit with rigid material, and air seal around the perimeter of the cap. If the soffit is located in a hard-to-access area, or along an exterior wall, consider dense-packing the soffit. When the soffit contains a non-IC rated light fixture, ensure any insulation will be kept at least 3 inches away from the top and sides of the fixture or obtain the homeowner’s approval to replace with an IC rated or flush mount fixture. ZPD sometimes reveals these areas do not leak. Consider testing prior to air sealing, and document based upon the test results the decision to seal or not seal.

2. **Around masonry chimneys:** Use 26- gauge or heavier metal and appropriate temperature rated sealant to seal within 3 inches of the chimney. A 3-inch clearance is required for flues and vents.
3. **Balloon framing/open partition walls:** Cap the stud openings with rigid material and air seal around the perimeter of the cap. Stuff the cavity with batts so the infill backing will not bend, sag, or move once installed. Seal with foam or dense pack with insulation.
4. **Recessed lights:** For IC rated fixtures, seal the fixture. Use sealant or mastic to prepare for insulation. For non-IC rated fixtures, either install an LED retrofit kit air sealed at the ceiling or build an airtight cover in the attic using non-combustible materials that do not allow for rapid heat transfer. Drywall or cement board may be used only if a three-inch clearance is maintained. Sheet metal is not an allowable material. Insulation cannot be installed over the top of the airtight cover to prevent heat buildup.
5. **Wall top-plates identified as leaking (exterior and interior walls):** Look for dirty insulation above top plates — this indicates air leakage. Pressurizing the home with the blower door will magnify smaller, hard-to-locate leaks. Use foam or caulk to seal leaky top plates. On multifamily homes, this leak path may be present at the top plate of party walls.
6. **Electrical and other penetrations through wall top-plates:** Use one-part foam or caulk.
7. **Ceiling penetrations:** These can include electrical fixtures, exhaust fans, soil stacks, dryer-exhaust pipes, HVAC ductwork, etc. Seal with foam or caulk, as appropriate. Seal from the interior when possible, rather than from the attic.
8. **Key junctures:** Key junctures are framing voids and shared spaces where two or more building assemblies converge. Use foam or caulk to seal key junctures. Another option is to utilize the bag method with cellulose. See *Installing Attic Insulation in 1½ Story Homes in Chapter 2 – Section 2.2.7* for information on the bag method.
9. **Whole-house fan:** If the fan is operational, box around it and install a cover that opens when the fan is operating and closes when the fan is turned off, the cover must be airtight when it is closed.
10. **Bath fans with heat source:** Build an airtight cover in the attic using non-combustible materials that do not allow for rapid heat transfer. Drywall or cement board may be used only if a three-inch clearance is maintained. Sheet metal is not an allowable material. Insulation cannot be installed over the top of the airtight cover to prevent heat buildup.

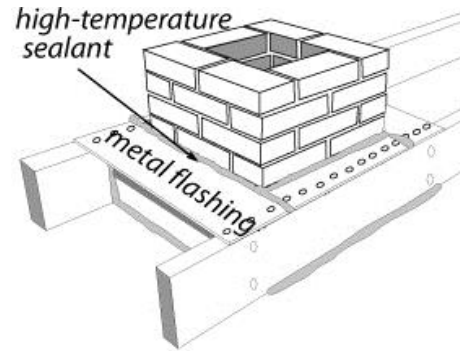

Sealing around chimneys: Only non-combustible materials, like metal, may be used for sealing around chimneys.

Foundations

1. **Sill Plate:** Apply a continuous seal with foam or caulk along the entire length of the gap between the sill plate and the foundation. Completing on the exterior will be more effective in most buildings.
2. **Rim Joist/Box Sill:** After sealing the sill plate, seal any leakage with foam or caulk. Look for dirty box sill insulation as evidence of air leakage. Using the blower door can magnify smaller leaks.
3. **Penetrations:** Use foam or caulk to seal large penetrations and cracks identified in the foundation. If the foam will be exposed to sunlight, take precautions to protect the foam from deterioration.

Basement

1. **Inactive chimneys and clean-outs:** Air seal to prevent leakage and reduce convective looping. Clearly label the chimney to state it is no longer suitable for use.
2. **Bathtubs on exterior walls:** Install dense-packed insulation in the open space between the bathtub and the exterior wall, if feasible.

Windows

1. **Missing window glass:** Install new window glass, or otherwise seal the opening, following lead- and asbestos-safe work practices. See *Window Repair and Replacement in Chapter 6 – Section 6.1.1* for information on window repairs and replacements. Air sealing of cracked window glass is considered Minor Air Sealing.

Doors

1. **Door repair:** Seal gaps between the stop and jamb with caulk. Sealing gaps between the door stop or jam falls under Minor Air Sealing.
2. **Garage doors:** Weather-strip all doors connecting conditioned areas to an attached garage.

1.5 Zone Pressure Diagnostics

ZPD tests help to quantify the air leakage from the house to intermediate “zones.” By using ZPD tests, workers can prioritize air sealing to areas of the pressure boundary where it will be most effective. ZPD tests may allow workers to save time working in zones whose air bypasses are insufficient to warrant extensive air sealing. Some common intermediate zones are attics, garages, and crawl spaces.

ZPD tests calculate a **total path** of CFM₅₀ leakage from the outside through the zone into the conditioned space. For example, a good goal for “all major attic bypasses” is the total path through all attics into the conditioned space should equal no more than 10 percent of the home’s total air leakage. For example, a home with a final blower door test of 2200 CFM₅₀ should have a total path through all intermediate attic zones of no more than 220 CFM₅₀.

When performing ZPD tests, use the auditors estimated final blower door test, not the in-progress blower door test, to calculate a zone’s leakiness. Document any unusual circumstances in the Comments section of the Blower Door Data worksheet within the Diagnostic Workbook.

Always perform ZPD testing when weatherizing a building with an attached garage. Record the results of the beginning ZPD test before starting air sealing and the final ZPD test on the Garage ZPD worksheet within the Diagnostic Workbook.

Use ZPD to guide decisions about where to direct air sealing efforts. ZPD can allow workers to:

1. Evaluate the airtightness of specific sections of a building’s pressure boundary — especially floors and ceilings.
2. Decide which of two possible air barriers to air seal — for example, sealing at the first-floor deck versus at the foundation walls. Please see *Table 1-2 in Chapter 1 – Section 1.5.3*.
3. Estimate the air leakage in CFM through a particular air barrier.
4. Determine whether areas like floor cavities, porch roofs, and overhangs are conduits for air leakage.
5. Determine whether building cavities, intermediate zones, and ducts are connected by air leaks.

ZPD testing should be used whenever appropriate. Typically, that is when the dwelling has one or more of the following conditions:

1. Structural moisture problems related to moist air escaping into unheated zones.
2. Multiple zones when determining linkage between zones or setting air sealing priorities is necessary.
3. Unusually high blower door result with no indication as to where the air leakage originates.
4. Results of completed ZPD should be documented on the required Zone Pressure Diagnostics Form within the Diagnostic Workbook.

Table 1-1: Air Performance of Building Components

Good Air Barriers (<2 CFM₅₀ per 100 ft.²)	Fair Air Barriers (2-10 CFM₅₀ per 100 ft.²)	Poor Air Barriers (10-1000 CFM₅₀ per 100 ft.²)
⁵ / ₈ " oriented strand board	15# perforated felt	⁵ / ₈ " tongue-and-groove wood sheathing
¹ / ₂ " drywall	concrete block	6" fiberglass batt
4-mil air barrier paper	rubble masonry	1 ¹ / ₂ " wet-spray cellulose

Good Air Barriers (<2 CFM ₅₀ per 100 ft. ²)	Fair Air Barriers (2-10 CFM ₅₀ per 100 ft. ²)	Poor Air Barriers (10-1000 CFM ₅₀ per 100 ft. ²)
asphalt shingles and perforated felt over 1/2" plywood	7/16" asphalt-coated fiberboard	wood siding over plank sheathing
1/8" tempered hard-board	1" expanded polystyrene	wood shingles over plank sheathing
painted un-cracked lath and plaster	brick veneer	blown fibrous insulation

Measurements taken at 50 pascal pressure.
Based on information from: "Air Permeance of Building Materials" by Canada Mortgage Housing Corporation, June 1988, and estimates of comparable assemblies by the author.
Although cellulose reduces air leakage when blown into walls, it is not considered an air barrier material.

Primary vs. Secondary Pressure Boundary

The **primary pressure boundary**, or air barrier, comprises those building shell surfaces which contain the dwelling's conditioned air and which prevent air leakage. Ideally, the primary pressure boundary will be as continuous as possible, and it will be aligned with the building's thermal boundary.

The **secondary pressure boundary** comprises building surfaces that are outside the thermal boundary and which combine with the primary pressure boundaries to form intermediate zones.

Intermediate zones are spaces that are isolated outside of the home's thermal boundary, but which are sheltered within the home's exterior shell. Intermediate zones may include such unconditioned areas as basements, crawl spaces, attics, enclosed porches, and attached garages. Pre-weatherization, intermediate zones may be included either inside the home's primary pressure boundary or outside it. One goal of weatherization is to improve the pressure boundary so these unconditioned zones are isolated outside the home's primary pressure boundary.

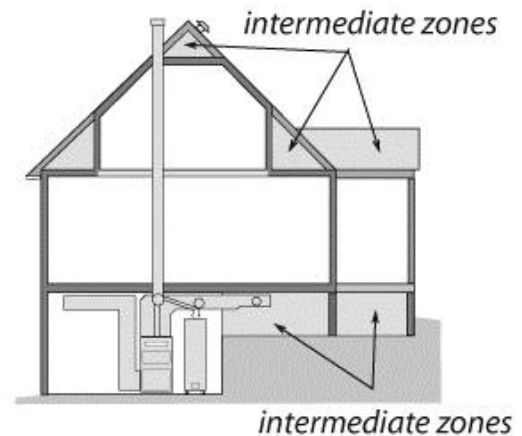

Intermediate zones have two potential pressure boundaries: one between the zone and house and one between the zone and outdoors. For example, an attic has two pressure boundaries: the ceiling and the roof deck. It is essential to determine which of the two serves as the primary pressure boundary.

After weatherization is complete, the most airtight boundary should be the primary pressure boundary and the least airtight should be the secondary pressure boundary. The primary pressure boundary should be adjacent to the insulation to ensure the insulation's effectiveness. The air barrier should be composed of materials that are continuous, sealed at seams, and relatively impermeable to air flow.

1.5.1 Simple Air Leakage Tests

During a blower door test, valuable information about the relative leakiness of rooms or sections of the home can be identified.

Following are five simple methods for locating air leakage.

1. **Feeling air leakage:** From inside the building along the primary pressure boundary, air movement will be felt during a depressurization test. From inside an intermediate zone along the primary pressure boundary, air movement will be felt during a pressurization test. Air leakage from a room can be felt by closing an interior door. A smaller gap between the door and doorjamb causes the air flow to speed up. Feel the air flow along the length of that crack and compare that air flow intensity with air flow from other rooms, using the same technique.
2. **Observing movement caused by air leakage:** To locate air leaks from the interior, depressurize the home and look for moving cobwebs, moving curtains, and blowing dust. To locate air leaks from intermediate zones, pressurize the home, and look for movement of loose-fill insulation, blowing dust, or moving cobwebs.
3. **Observing smoke movement:** Using a smoke generator to detect areas of air leakage is the best method to diagnose primary pressure boundary air leakage during a **pressurization** test.
4. **Thermal Imaging:** Observe surfaces with an infrared camera. Areas of high contrast or flaring along building trim can indicate the presence of air leakage. Observing surface before and then after running blower door can indicate changes in temperature of surface caused by air leakage.
5. **Room air flow difference:** Measure the house CFM_{50} with all interior doors open. Close the door to a single room or the basement and note the difference in the CFM_{50} reading. The difference is the approximate leakage through that room or the basement.

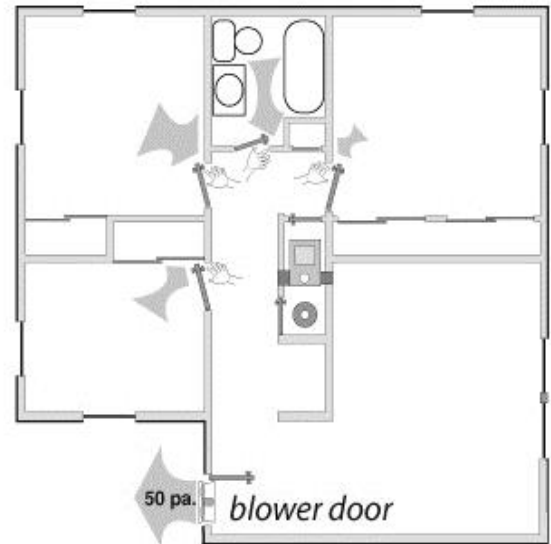

Interior door test: Feeling air flow with your hand at the crack of an interior door gives a rough indication of the air leakage coming from the outdoors through that room.

Tests 1 - 3 can be completed by the occupant as part of customer education. Feeling for air flow or observing smoke are simple observations and can identify many air leaks or reveal that windows and doors have minimal air leakage. Tests 4 - 5 require experience to interpret observations. High contrast surfaces may appear that way when using an infrared camera because they are warmer or cooler. This may be caused by lack of cavity insulation, or by air leakage across or behind the surface. When air flow within the home is restricted by closing a door, as in test 5, it may take alternative indoor paths that reduce the accuracy of the test.

Experience and training can guide decisions about the applicability and usefulness of these simple tests.

1.5.2 Using a Digital Gauge to Test Pressure Boundaries

A digital gauge, used for blower door testing, can also measure pressures between the house and its intermediate zones during blower door tests. The blower door, when used to create a house-to-outdoors pressure difference of 50 pascals, also creates house-to-zone pressures that can range from 0 to 50 pascals in the building's intermediate zones. The amount of pressure differential depends on the relative leakiness of the zone's two pressure boundaries.

For example, in an attic with small holes in the ceiling and a well-ventilated roof, the house-to-zone pressure may be 45 to 50 pascals. This attic is described as being “mostly outside” the house pressure boundary. The larger the holes in the ceiling with smaller holes in the roof, the smaller the house-to-zone pressure differential will be, and the more the attic could be described as “being inside.” This principle holds true for other intermediate zones like crawl spaces, attached garages, and unheated basements.

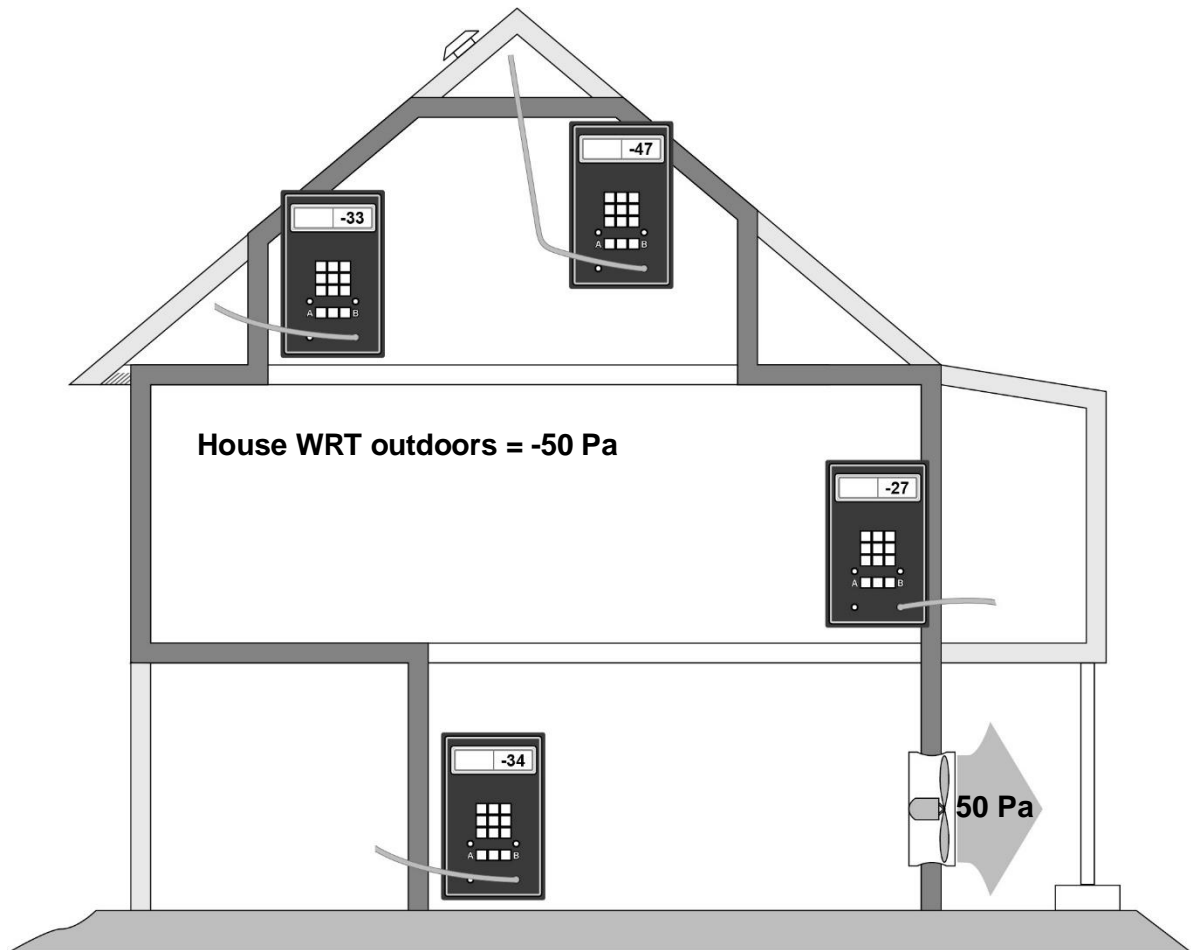

Pressure-testing building zones using a DG-700: Measuring the pressure difference across the assumed thermal boundary tells you whether the air barrier and insulation are aligned. If the digital gauge reads close to -50 pascals, they are aligned, assuming the tested intermediate zones are well-connected to outdoors.

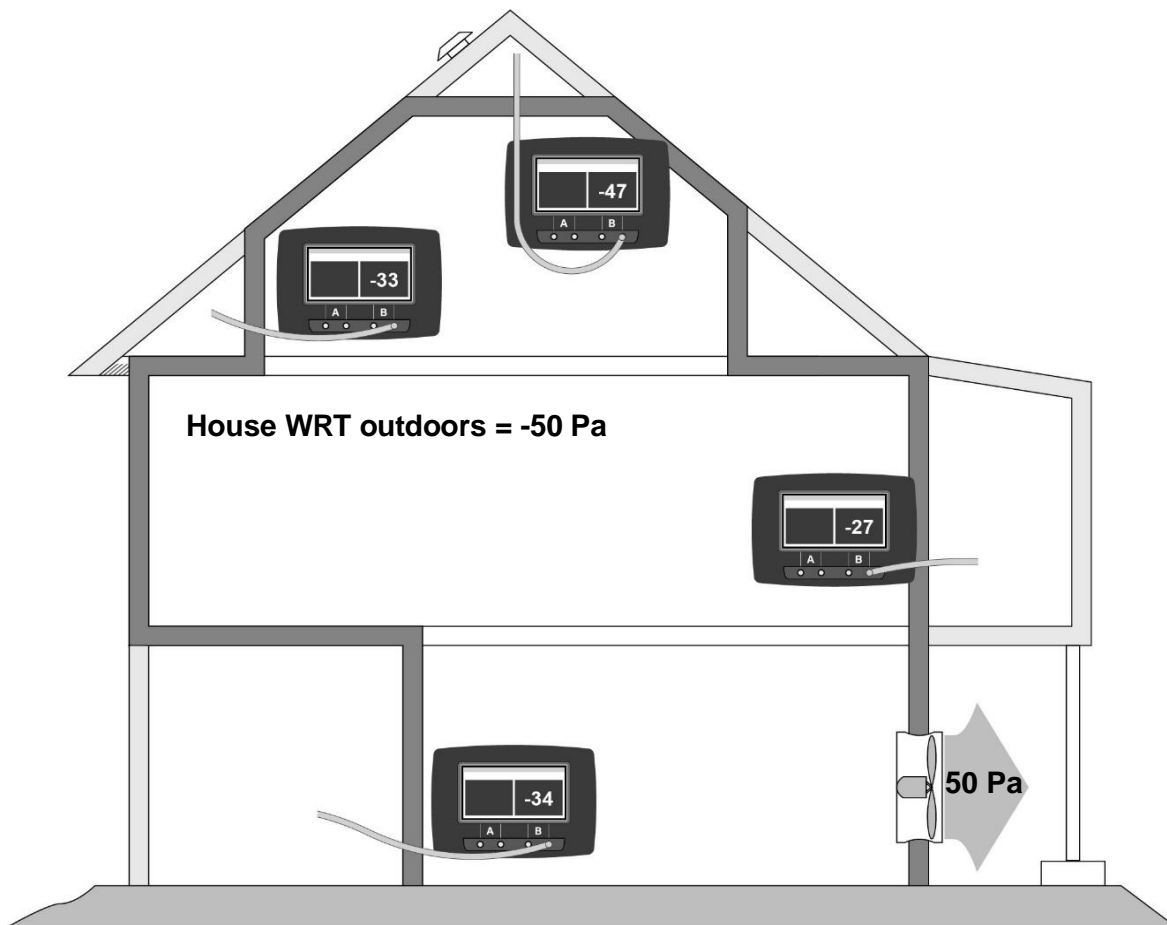

Pressure-testing building zones using a DG-1000: Measuring the pressure difference across the assumed thermal boundary tells you whether the air barrier and insulation are aligned. If the digital gauge reads close to -50 pascals, they are aligned, assuming the tested intermediate zones are well-connected to outdoors.

Pressure-Only Zone Pressure Diagnostics

1. Find an existing hole between the conditioned space and the intermediate zone. Or, with the customer's permission, drill a hole through the floor, wall, or ceiling into the zone.
2. Run a hose into the zone and connect the hose to the Channel B reference tap of the digital gauge.
3. Leave the Input tap of the digital gauge open to the indoors.
4. Turn the blower door on and create a 50-pascal pressure difference between the House with reference to Outside (HwrtO) using Channel A.
5. Read the pressure differential on Channel B. This is the House with reference to Zone (HwrtZ) pressure differential. As a rule, readings close to 50 pascals indicate the zone is less connected to the house compared to the connection to outdoors. Test readings much lower than 50 pascals generally indicate the presence of air leaks along the primary pressure boundary. The lower the house to zone pressure, the greater the size of holes from the house to the zone.

The main principle of series air leakage is a direct relationship between the measured pressure differentials and the ratio of the size of holes in the primary and secondary pressure boundaries.

This method allows the user to calculate the air leakage surface area through one of the boundaries if the air leakage surface area through the other boundary is known or presumed.

For example, testing may indicate a HwrtZ pressure differential of 41 Pa and a Zwrto differential of 9 Pa, when the HwrtO pressure difference is 50 Pa. Per the Attic Bypass Relationships chart, if the secondary pressure boundary (roof) contained 300 square inches of ventilation, then this would indicate the presence of roughly 100 square inches of bypasses located in the primary pressure boundary (ceiling).

Attic Bypass Relationships		
Zone Pressures		Relative Size of Bypass Holes Compared to Roof Holes (e.g., ventilation)
Zwrto	HwrtZ	HwrtZ
1	49	1/13
2	48	1/8
5	45	1/4
9	41	1/3
13	37	1/2
25	25	1
38	12	2

- If testing indicates the presence of substantial air leaks, find and seal the air barrier's leaks.

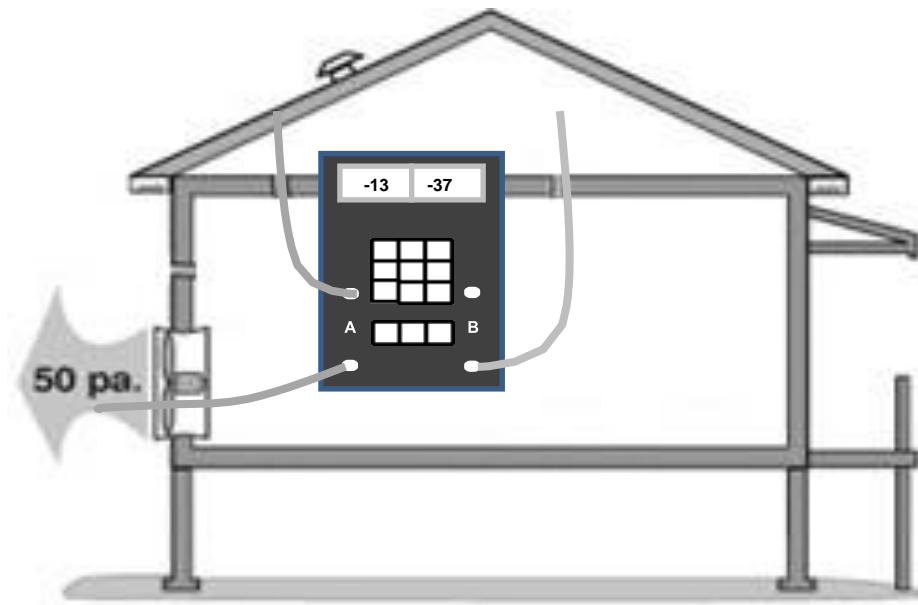

Attic-to-outdoors pressure: The left side of the gauge shows an attic WRT outside pressure of -13 pascals and the right side of the gauge shows a House WRT Attic pressure of -37 pascals. The two readings add up to -50 pascals to confirm House WRT Outside of 50 pascals.

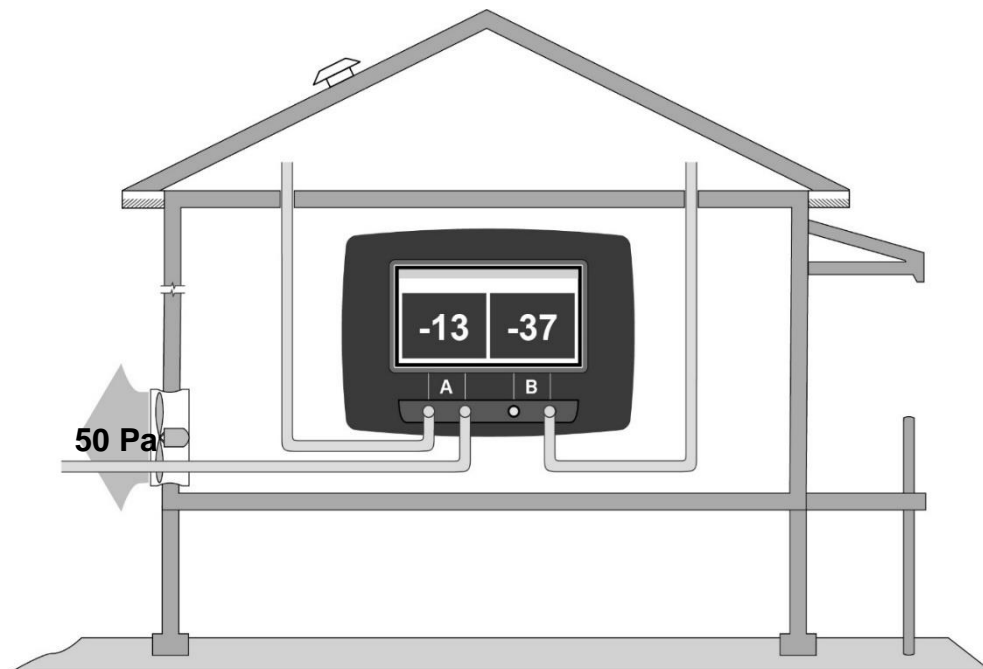

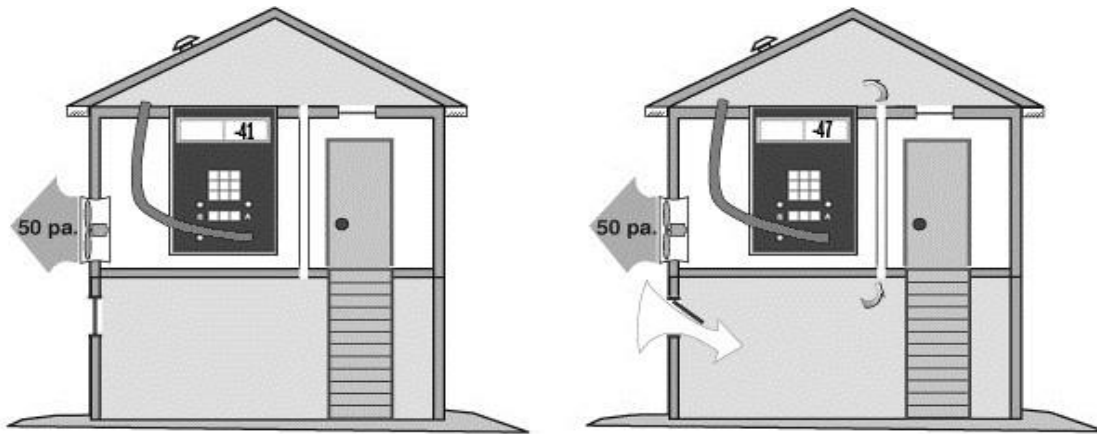

Zone connectedness: The attic measures closer to outdoors after the basement window is opened, indicating the attic and basement are connected by a large bypass.

These examples assume that the digital gauge is outdoors with the reference port open to outdoors

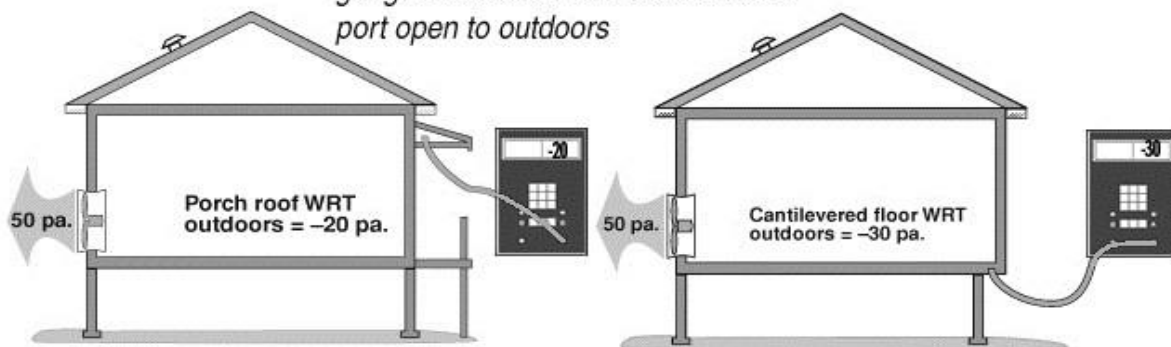

Porch roof test: If the porch roof were outdoors, the digital gauge would read near 0 pascals. We hope the porch roof is outdoors because it is outside the insulation. We find, however, it is partially connected to indoors, indicating it may contain significant air leaks through the thermal boundary.

Cantilevered floor test: We hope to find the cantilevered floor to be indoors. A reading of -50 pascals would indicate that it is completely indoors. A reading less negative than -50 pascals is measured here, indicating that the floor cavity is partially connected to outdoors.

Leak-Testing Building Cavities

Building cavities such as wall cavities, floor cavities between stories, and dropped soffits in kitchens and bathrooms can also be pressure-tested with a digital gauge to determine their connection to the outdoors.

Testing Zone Connectedness

Sometimes it is useful to determine whether two intermediate zones are connected by an air passage like a large bypass. Determining whether two zones are connected can be completed by measuring the house-to-zone pressure during a blower door test and then later after opening the other zone to the outdoors. Opening an interior door leading into one of the zones and

checking for pressure changes in the other zone can also help determine connections.

1. Turn on the blower door and establish a house-to-outside pressure differential of 50 pascals.
2. Test and record the house-to-zone pressure differential of one of the zones.
3. Open a door, or create some other pathway, into the other zone.
4. Re-establish a house-to-outside pressure differential of 50 pascals, as opening the pathway will change the overall house pressure.
5. Re-test the house-to-zone pressure differential in the first zone. If opening the pathway has caused the test result to change, then this is evidence of a connection between the two zones.

1.5.3 Locating the Pressure/Thermal Boundary

Where to air seal and insulate are important retrofit decisions. Zone pressures are one of several factors used to determine where the thermal boundary should be located. When there are two choices of where to insulate and air seal, zone pressures along with other considerations help decide where to locate the pressure and thermal boundaries.

For zone leak-testing, the house-to-zone pressure is often used to determine which of the two pressure boundaries is tighter (has smaller sized holes).

For example, a house-to-zone pressure differential of 26 to 50 pascals means the primary pressure boundary is likely tighter than the secondary boundary. If the secondary boundary is quite airtight, achieving a 50-pascal house-to-zone pressure differential is difficult. However, if the roof is well ventilated, creating a nearly 50-pascal differential is possible. If the roof is over-ventilated, creating a nearly 50-pascal differential is easy.

By contrast, a house-to-zone pressure differential of zero to 25 pascals means the secondary pressure boundary is tighter than the primary boundary. If the roof is well ventilated, then these readings indicate the ceiling has even more leakage surface area than the roof.

Floor vs. Crawl Space

The floor shown here is tighter than the crawl space foundation walls. If the crawl space foundation walls are insulated, holes and vents in the foundation wall should be sealed until the pressure difference between the crawl space and outside is as close to 50 pascals as possible—ideally more than 48 pascals. A leaky foundation wall renders its insulation ineffective.

It might be more effective to weatherize the floor above the crawl space. If the floor is insulated instead of the foundation walls, completely air sealed, then the pressure and the thermal boundary would be in alignment at the floor. When the crawl space is adjacent to a basement

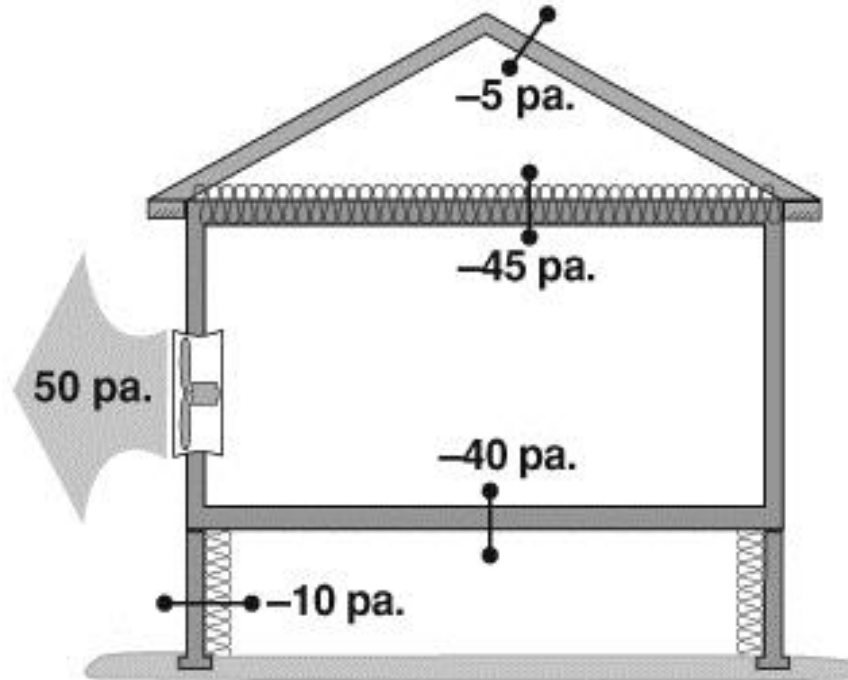

Pressure measurements and air barrier location: The air barrier and insulation are aligned at the ceiling as they should be. The crawl space pressure measurements show that the floor is the air barrier and the insulation is misaligned—installed at the foundation wall. We could decide to close the crawl space vents and air seal the crawl space. Then the insulation would be aligned with the air barrier.

and the thermal boundary is to be moved to the floor, remember the thermal boundary now includes the wall separating the basement from the crawl space. Insulate and air seal this wall appropriately.

However, it will usually make more sense to locate the thermal boundary at the crawl space foundation walls, rather than at the floor. Locating the thermal boundary at the foundation walls eliminates the concern about frozen pipes in the crawl space. In addition, treating the foundation walls usually requires less work and material than treating the floor.

Table 1-2: Crawl Space: Where Should the Air Barrier Be?

Factors Favoring Foundation Wall	Factors Favoring Floor
Ground moisture barrier and good perimeter drainage present or planned	Damp crawl space with little or no improvement offered by weatherization
Foundation walls test tighter than floor	Floor tests tighter than foundation walls
Furnace, ducts, and plumbing located in crawl space	No plumbing or heating located in crawl space
Foundation wall is insulated	Floor is insulated

Table 1-3: Unoccupied Basement: Where Should the Air Barrier Be?

Factors Favoring Foundation Wall	Factors Favoring Floor
Ground drainage and no existing moisture problems	Damp basement with no solution during weatherization
Interior stairway between house and basement	Floor air sealing and insulation is a reasonable option, considering access and obstacles
Ducts and furnace in basement	No furnace or ducts present
Foundation walls test tighter than the floor	Floor tests tighter than foundation walls
Basement may be occupied someday	Exterior entrance and stairway only
Laundry in basement	Rubble masonry foundation walls
Floor air sealing and insulation would be very difficult	Dirt floor or deteriorating concrete floor
Concrete floor	Badly cracked foundation walls

Garage Boundary

For a tuck-under or attached garage, locate the thermal and pressure boundaries at the floor and walls that separate the garage from the living spaces. Ensure plumbing pipes in these floor and wall cavities are located on the interior (warm) side of the thermal and pressure boundaries to prevent frozen pipes.

For tuck-under garages, make sure to air seal the floor-joist key juncture above the wall that separates the garage from the home. Use the Bag Method if necessary. See *Installing Attic Insulation in 1½ Story Homes (Finished Attics)* in Chapter 2 – Section 2.2.7 on for more information about the Bag Method.

Duct Location

Whenever feasible, locate the thermal and pressure boundaries to include ductwork. This is a better option than isolating the ducts outside the thermal boundary, because it reduces energy waste from duct leakage.

1.5.4 Add-A-Hole Zone Leakage Measurement

The Add-A-Hole procedure estimates the actual air flow between the house and zone. Use the Add A Hole worksheet within the Diagnostic Workbook to perform the calculations described here. This procedure works for most intermediate zones that have an opening or access to the indoors.

The Add-A-Hole worksheet calculates Leakage Results based on user data inputs. The three Leakage Results calculations are:

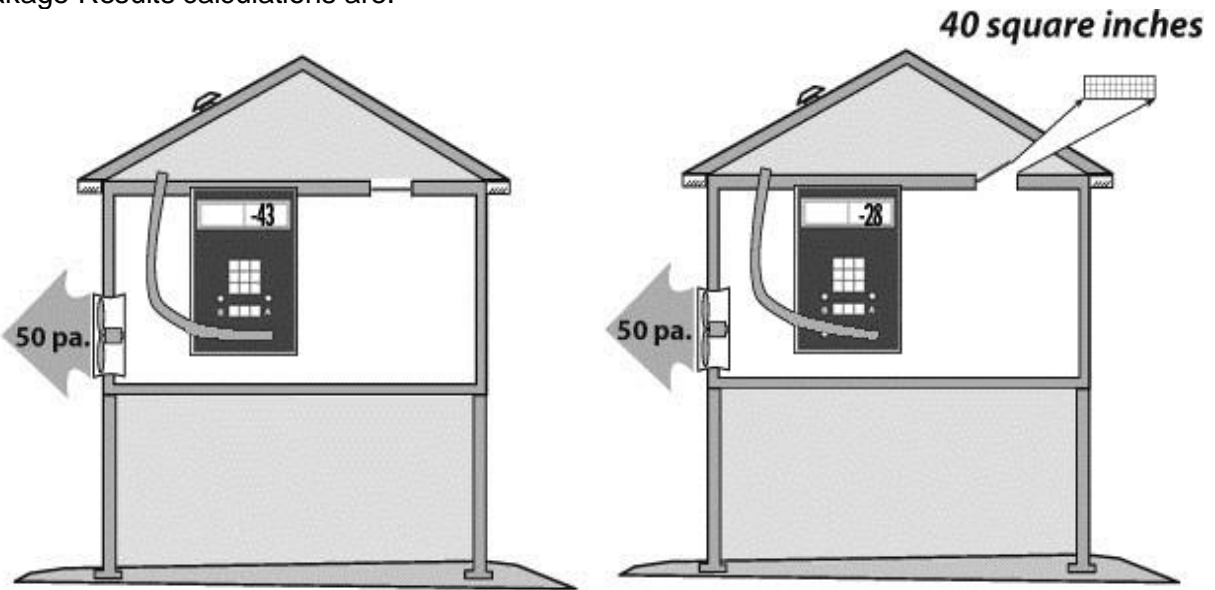

Add-A-Hole test: The first house-to-attic pressure is -43 pascals. This test works equally well with crawl spaces and attached garages.

Add-A-hole Test 2: Opening a hole of approximately 40 square inches drops the second house-to-zone pressure by 15 pascals.

Total path: This number represents the amount of leakage (in CFM₅₀) passing through both pressure boundaries.

House with reference to Zone: This number represents the amount of leakage between the house and zone.

Zone with reference to Outside: This number represents the amount of leakage between the zone and outside.

Ideally, total path leakage percentage through attics is ten percent or less of the total blower door value. This number is calculated using the following equation:

$$\text{Percentage} = \text{Total Path} \div \text{Whole-House CFM}_{50}$$

Before starting an Add-A-Hole Zone Leakage Test, confirm a “hole” can be opened between the house and the zone and/or between the zone and the outside. The hole might be an attic hatch, a door to the zone, or some other opening.

Follow these steps to complete the Add-A-Hole ZPD test:

1. Set up for a standard blower door test. Put the home in winter operating condition, turn off all combustion appliances, and keep interior doors open and stationary during testing.
2. Run a reference pressure hose to a location outdoors unaffected by the wind. Run a second pressure hose into the zone, keeping the hose end away from air currents that

could be caused by roof vents and large bypasses. Both hoses will be connected to the digital gauge later during the test. Ensure both hoses are long enough to reach the gauge at the same time.

3. Turn on the pressure gauge and leave in PR/PR mode for all testing. *Do not use the Adjusted Baseline feature of the digital gauge when completing Zone Pressure Diagnostics.*
4. Connect a jumper tee to the Channel A Input tap and the Channel B reference tap. Leave the jumper tap open to the indoors for the time being, with no hose connected. Connect the outdoor pressure hose to the Channel A reference tap of the digital gauge.
5. Open the Add A Hole worksheet in the Diagnostic Workbook. Select the Type of Test — depressurization or pressurization — to be conducted.
6. Connect the zone pressure hose to the jumper tee. Record the baseline pressures, the Zone with reference to Outside (ZwrtO) baseline from Channel A, and the House with reference to Zone (HwrtZ) baseline from Channel B.

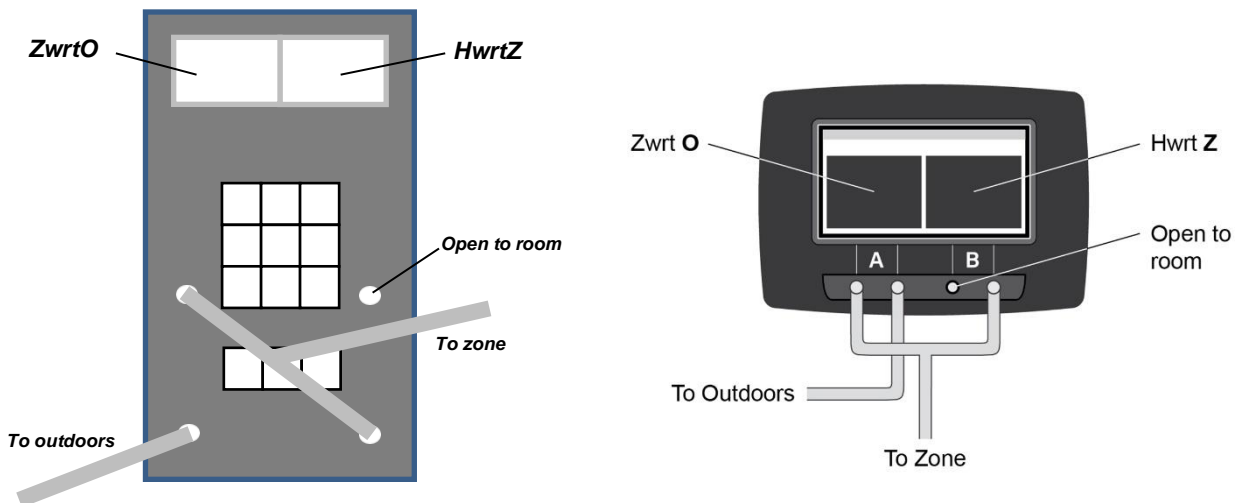

7. Remove the zone pressure hose. Measure the House with reference to Outside (HwrtO) baseline pressure differential. Enter the result in the Diagnostic Workbook, as a positive or a negative number. The Workbook will then calculate the Adjusted Pressure — which becomes the target building pressure for the blower door test.
8. Start the bower door fan to create an HwrtO pressure difference and adjust the fan speed to within 1 pascal of the target building pressure.
9. Without changing the fan speed, reconnect the zone pressure hose to the jumper tee. Record the ZwrtO reading from Channel A in the Pressure with House at 50 pascals line of the Add A Hole worksheet. Record the HwrtZ reading from Channel B in the same line of the worksheet.
10. Turn off the blower door fan. Create a hole by opening the access between the zone and the house. The size of the hole created should be sufficient to change the measured HwrtZ Pressure with House at 50 pascals by 6 to 20 pascals. A hole that is too large or too small may lead to incorrect results.

11. Repeat Steps 6-9. If the HwrtZ reading is more than 20 pascals different, reduce the size of the hole. If the HwrtZ reading is fewer than 6 pascals different, increase the size of the hole. *If the size of the hole is changed, the baseline pressures will change, and should be re-measured (go back to Step 6).*
12. Determine the surface area of the final hole, in square inches. Be sure to account for the triangular spaces created on either side of the access hatch if the hatch was tilted open. Enter the dimensions of the opening so the Add A Hole worksheet calculates an Opening Size to match the hole's measured surface area.
13. When the HwrtZ reading from Channel B falls within the range of 6 to 20 pascals difference, record it in the Pressure with House at 50 pascals line of the Add A Hole worksheet in the "Pressure Readings After Adding a Hole" section. Record the Zwrto reading from Channel A in the same line of the worksheet.
14. The worksheet will calculate leakage rates and total path leakage. Return the home to the pre-test conditions — and remember to turn combustion appliances back on.

Follow the warning indicators in the Add A Hole worksheet, if they appear.

1.5.5 Open-A-Door Zone Leakage Measurement

The Open-A-Door method is another way of determining how much leakage in CFM₅₀ travels through an intermediate zone like a walk-up attic, unoccupied basement, or attached garage. This method is used when a door exists between the house and zone or between the zone and outdoors. Use the Open A Door or garage ZPD worksheet within the Diagnostic Workbook to perform the calculations.

The Open A Door worksheet calculates Leakage Results based on user data inputs. The three Leakage Results calculations are:

Total path: This number represents the amount of CFM₅₀ passing through both pressure boundaries.

House with reference to Zone: This number represents the amount of leakage between the house and zone.

Zone with reference to Outside: This number represents the amount of leakage between the zone and outside. If the attic is the zone, this is attic ventilation.

The target air leakage between a house and an attached garage is 50 CFM. Ideally the goal should be to have no leakage between a house and garage.

Follow these steps to complete the Open-A-Door test:

1. Set up for a standard blower door test. Put the home in winter condition, turn off all combustion appliances, and keep interior doors open and stationary during testing.

2. Run a pressure hose to the outdoors to a location unaffected by wind. Run a second pressure hose into the zone, keeping the hose end away from roof vents and large bypasses that may create air currents. Both hoses will be connected to the digital gauge later during the test. Ensure both hoses are long enough to reach the gauge at the same time.
3. Turn on the pressure gauge and leave in PR/PR mode for pressure testing. *Do not use the Adjusted Baseline feature of the digital gauge when completing Zone Pressure Diagnostics.*
4. Connect a jumper tee to the Channel A Input tap and the Channel B reference tap. Leave the jumper tap open to the indoors for the time being, with no hose connected to the third leg of the tee. Connect the outdoor pressure hose to the Channel A reference tap of the digital gauge.
5. Start the Open A Door or Garage ZPD worksheet in the Diagnostic Workbook. Select the Type of Test — depressurization or pressurization — to be conducted.
6. Connect the zone pressure hose to the jumper tee. Record the baseline pressures, the Zone with reference to Outside (ZwrtO) baseline from Channel A, and the House with reference to Zone (HwrtZ) baseline from Channel B.
7. Remove the zone pressure hose. Measure the House with reference to Outside (HwrtO) baseline pressure. Enter the result in the Diagnostic Workbook, as a positive or a negative number. The Workbook will then calculate the Adjusted Pressure — which is the target building pressure reading for the blower door test.
8. Start the blower door fan to create an HwrtO pressure difference and adjust to within 1 pascal of the targeted pressure reading.
9. Without changing the fan speed, reconnect the zone pressure hose to the jumper tee. Record the ZwrtO reading from Channel A in the Pressure with House at 50 pascals line of the Open A Door or Garage ZPD worksheet. Record the HwrtZ reading from Channel B in the same line of the worksheet.
10. Complete the blower door test with the door to the zone closed and record the reading on the worksheet.
11. Open the door between the house and the zone. The door to be opened will be between the basement and the outside when determining leakage to the basement from outside.
12. Complete a blower door test with the door wide open and record on the Open A Door or Garage ZPD worksheet.
13. The worksheet will calculate leakage rates and total path leakage. Return the building to the pre-test conditions — and remember to turn combustion appliances back on.

Follow the warning indicators in the Open A Door or Garage ZPD worksheet, if they appear.

The sum of the HwrtZ and ZwrtO pressures should be approximately equal to the actual HwrtO pressure. For example, if the HwrtZ pressure is -45 pascals and the ZwrtO pressure is -6 Pa,

then the indirect HwrtO pressure will calculate out to -51 pascals ($-45 + -6 = -51$). The greater the difference between the HwrtO and the sum of the HwrtZ + ZwrtO pressures, the less accurate the test will be. If the sum difference is greater than 2 pascals, the worksheet will instruct workers to consider re-testing.

1.5.6 Adjusting Zone Pressure Measurements for Baseline

The Diagnostic Workbook automatically adjusts test results to measured baseline pressures. However, it is important to understand how baseline pressures (caused by stack effect, wind, or air handlers and fans) affect zone pressure measurements. The measured zone pressure baseline readings are subtracted from the measure zone pressure readings taken with the house at a 50-pascal pressure difference. This can be confusing when subtracting a negative number from a negative reading (depressurization) or a positive reading (pressurization). The number lines below are examples on how to adjust for baseline for both pressurization and depressurization testing methods.

Pressurization

Positive baseline of +2, zone reading of 40 with house at 50. Adjusted zone pressure reading is 38 ($40 - (+2) = 38$).

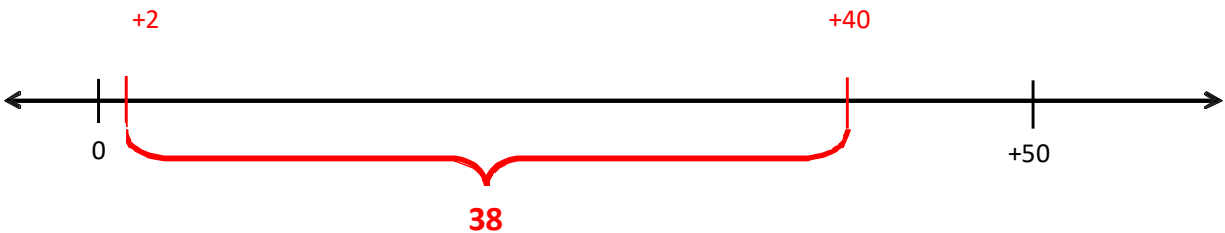

Negative baseline of -3, zone reading of 40 with house at 50. Adjusted zone pressure reading is 43 ($40 - (-3) = 43$).

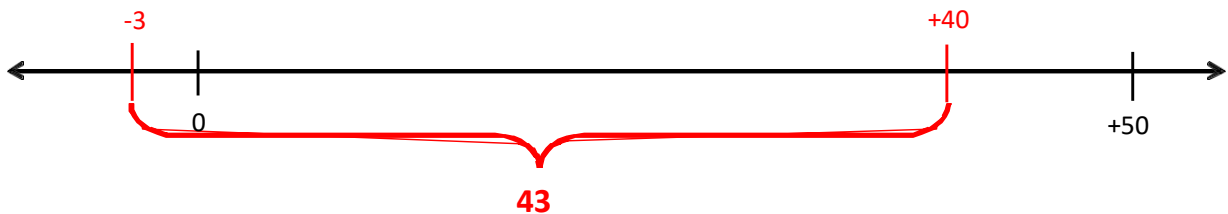

Depressurization

Positive baseline of +3, zone reading of -35 with house at -50. Adjusted zone pressure reading is 38 ($-35 - (+3) = -38$).

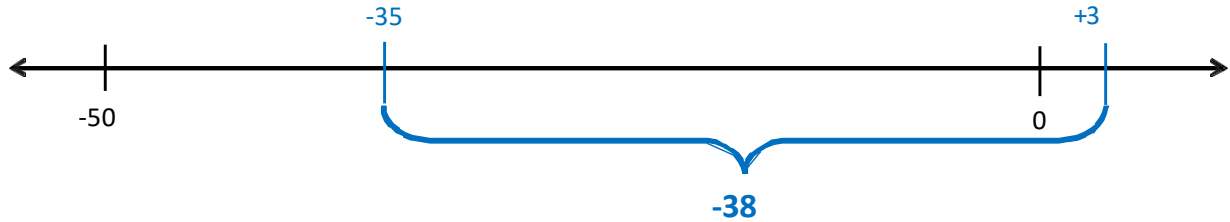

Negative baseline of -2, zone reading of -45 with house at -50. Adjusted zone pressure reading is 43 ($-45 - (-2) = -43$).

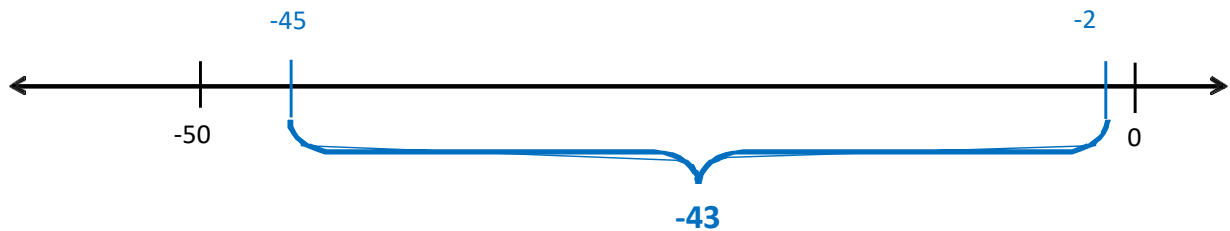

Final Inspection and Quality Assurance Standards

Acceptable installations shall meet the following standards.

Air Sealing and Building Diagnostics

General

1. The customer file contains documentation of all diagnostic, air sealing, and combustion safety testing that was performed at the building.
2. Diagnostic tests were appropriate for the building's configuration.
3. Program guidelines were followed in reducing air leakage (e.g., major and minor air sealing and ZPD testing).

Air Sealing

1. All major attic bypasses and building key junctures are sealed.
2. All significant leakage in the foundation and box sill are air sealed.
3. Broken or missing windows or windowpanes have been patched, repaired, or replaced.
4. The air sealing hours and testing are documented in the Diagnostic Workbook.
5. Air sealing materials perform the intended function. When cavities are dense packed with cellulose to the proper density, chemical smoke will not be seen to move through penetrations, even when the building is at a pressure differential of 50 pascals.
6. Paintable caulk was used where the occupant or owner is likely to paint the completed work.
7. Foam sealant, if used, was applied effectively and without waste. Overspray was cleaned up.
8. Weather-stripping is installed only on doors that exit from the conditioned space including doors leading to the garage.

Blower Door Test

1. The equipment was calibrated per manufacturer instruction.
2. The final temperature/altitude blower door value can be replicated to +/- 10%. (Final Inspection, QA Inspection).
3. The Diagnostic Workbook is complete.

Zone Pressure Diagnostics

1. ZPD testing was performed on the attached garage and is properly documented in Diagnostic Workbook.
2. The appropriate method was used when ZPD testing was completed (e.g., Open-A-Door, Add-A-Hole).
3. Total path leakage results are within acceptable range or documentation supports work as completed.

Chapter 2: Heating Envelope Building Measures

2.1 Heating Envelope Insulation

The building heating envelope comprises those surfaces that function as the thermal boundary between conditioned and unconditioned spaces. These surfaces may include, but are not limited to, exterior walls, attics, foundations, and exposed floors. Insulation reduces heat transmission by slowing conduction, convection, or radiation through the building envelope. The various insulating materials in the building make up the *thermal boundary* — the boundary that separates conditioned space from unconditioned space. Airtight materials that cover the walls, floor, and ceiling to prevent air movement form the *pressure boundary*. The thermal and pressure boundaries should be as continuous as possible and aligned properly so the insulation works effectively. The pressure boundary must be addressed before proceeding with work on the thermal boundary except in circumstances where both pressure and thermal boundaries are addressed at the same time, through measures such as dense-pack insulation. See *Chapter 1 – Section 1.5.3* for information on how to address the pressure boundary.

When insulation is installed, a dated insulation certificate is affixed near an attic hatch, electrical panel, or other visible location, with information including:

1. Insulation type
2. Coverage area
3. R-value
4. Installed thickness and settled thickness
5. Number of bags installed in accordance with manufacturer instructions
6. SPF insulation shall include:
 - a) Type of two-part foam
 - b) Density
 - c) Flame and smoke spread

Spray Polyurethan Foam (SPF) and rigid insulation require a flame spread and smoke development index of 75/450 or less when testing in accordance with ASTM E84 or UL 723, and all other insulation requires an index of 25/450 or less. SPF used for duct sealing or insulation requires a flame spread and smoke development index of 25/450 or less. Refer to Appendix C in the Weatherization Program Manual for additional material specifications.

2.2 Attic and Roof Insulation

2.2.1 Pre-insulation Attic and Roof Insulation Prep

Perform these preparatory steps and safety procedures before installing attic insulation:

1. Vent all exhaust appliances to the outdoors, as specified in *Chapter 3 – Section 3.14* using a dedicated exhaust termination. Seal and insulate exhaust ducts to R-8 to prevent

condensation inside the duct. Check all fans for proper backdraft-damper operation. Repair or replace the damper, or the entire fan assembly, if the damper does not operate freely.

2. Isolate insulation a minimum of 3 inches from active masonry chimneys and per manufacturer instruction for metal vents, using rigid boxing material. When a properly sized gas liner is installed in an oversized masonry chimney, boxing is not required. Do not allow insulation to spill into clearance spaces.
3. Repair roof leaks and address other attic-related moisture problems before insulating the attic.
4. Confirm all wire splices are enclosed in electrical junction boxes. Mark all junction boxes that will be covered with insulation with a sign or flag.
5. When not removing knob-and-tube wiring, maintain a 3-inch clearance from insulation around live knob-and-tube wiring using appropriate materials. See *Electrical Safety in Chapter 5 – Section 5.7*.
6. Remove or perforate existing vapor retarders on the cold side of the insulation.
7. Check the manufacturer's instructions to determine if fixtures can be covered with insulation. If fixtures cannot be covered with insulation, or if Insulation Contact (IC) rating is unknown, keep all insulation three inches from these fixtures and do not install insulation over the top of the cover. See *Air Sealing in Chapter 1 – Section 1.4.1 (4)*.
8. If forced-air distribution (heating and/or air conditioning) runs through the attic, seal and insulate as appropriate (see *Duct Leakage and Duct Insulation in Chapter 3 – Sections 3.4.2 and 3.4.3*). Do not apply duct insulation to ducts that will be surrounded by R-8 or more of loose-fill insulation.
9. If the attic is used for storage, eliminate or reduce the amount of storage area with the customer's approval. Build an insulation dam around the storage area. If items are present during insulation, temporarily either remove items from area or cover with plastic or a tarp.
10. Install depth markers for installed insulation every 300 square feet of attic area, with the measurement beginning at the air barrier.
11. When a whole-house cooling fan is encountered in a home, construct a box around the fan at a height to protect the fan housing and motor from insulation. Insulate the exposed sides and top of the box assembly to the same R-value as the adjoining insulation. Use the appropriate adhesive or mechanical fasteners.
12. Boxing around the fan in the attic is the preferred method. When boxing is not an option, consider placing fiberglass batt on top of the exhaust fan housing before blowing insulation to prevent loose-fill insulation from spilling into the home if the fan is replaced in the future.

2.2.2 Attic Ventilation

Install attic ventilation when it is needed. When installing ventilation, there should be an equal distribution of vent area across all attic areas whenever possible. Split the net free area of attic ventilation equally between high and low venting, if possible. Consult state and local building codes for requirements on the minimum amount of attic ventilation.

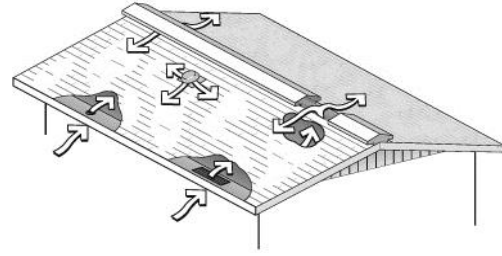

Low and high attic ventilation: A moderate amount of ventilation creates air exchange with outdoors.

Gable Vents

Install gable end vents as high in the gable end as possible and above the final level of the attic insulation. Build a dam in front of existing gable vents if insulation comes up to the bottom of the vent.

Roof Vents

Install the top flashing of the roof vents under asphalt shingles and mechanically fasten and seal with plastic roof cement or with products specifically designed for this purpose. Center all roof vents between rafters. Where possible, mount vents no closer than 12 inches (measured vertically) from the ridge of the roof.

Soffit Vents

When soffit venting is required, use products specifically designed for this purpose. Eave chutes allow the installation of the maximum amount of insulation over the exterior top-plate. Chutes can also prevent wind-washing of the insulation, which degrades the insulation's R-value. Install eave chutes as necessary to promote sufficient ventilation of the attic.

Mechanically fasten eave chutes at the top and install blocking at the base to prevent insulation from spilling over into the soffit area. In rafter cavities where a chute is not installed, make sure the cavity is blocked with fiberglass batts or a rigid barrier to prevent spillover into the soffit area. Chutes must be long enough to extend at least 6 inches above the final insulation level, and at least one inch of clearance between the insulation and roof deck material.



Soffit chute: Allows installation of maximum amount of insulation in this cold area. Also prevents wind washing and airway blockage by blown insulation.

2.2.3 Attic Accesses, Walk-up Stairways, and Doors Attic Accesses

Perform these tasks to address attic accesses, walk-up stairways, and doors prior to insulation:

1. Insulate accessible attic accesses to the R- value of the adjacent attic insulation or to the maximum structurally allowable, whichever is lower. Permanently attach the insulation and ensure it is in complete contact with the air barrier. Access must be operable, weather-stripped, and air sealed.
2. Install durable boxing material to maintain the R- value of the attic insulation up to the access, allow repeated access to the attic, and to prevent loose-fill insulation from entering the home.
3. Post warnings in access to attics with asbestos-containing materials or vermiculite. See the Wisconsin Weatherization Program Manual (Chapter 9 – Health & Safety) for more information about asbestos.



Walk-Up Stairways and Doors

Establish a continuous insulation and air barrier around or over the top of an attic stairway. If the attic is accessed using a stairwell and standard vertical door, there are two methods for treatment.

Method 1

Insulate the walls of the stairwell, as well as beneath landings, stair treads, and risers. Insulate and weather-strip the back of the door to the R-value of the adjacent wall insulation or the maximum structurally allowable, whichever is lower.

When planning to insulate stairwells, investigate for barriers, such as fire blocking, that might prevent insulation from filling cavities. Consider which passageways may lead to other areas where insulation should not be installed, such as closets or chimney chases. Balloon framed walls and deep stair cavities complicate this measure.



Method 2

Establish the thermal boundary at the ceiling level by installing an insulated and air sealed horizontal hatch at the top of the stairs. Insulate the hatch to the R-value of the adjacent attic insulation or the maximum structurally allowable, whichever is lower.

Insulating and Sealing Retractable Attic Stairways

Building an insulated box is a good solution to insulating and sealing this weak point in the thermal boundary. Insulate the box and the cover to an R-value equal to the attic insulation level, or to the highest R-value structurally allowable. Use care in establishing a continuous thermal boundary when air sealing and insulating around the hatch opening.



2.2.4 Calculating Attic Loose-Fill Insulation

Install loose-fill attic insulation at a uniform depth to attain proper coverage (bags per square foot) and proper R-value at the manufacturer's specified installed thickness. Follow the manufacturer's instructions in order to achieve the correct density to meet the required R-value.

Loose-fill insulation always settles, and the manufacturer does account for settling in the listed minimum installation thickness charts. The installed thickness of cellulose decreases by 10 to 20 percent due to settling, and the installed thickness of blown fiberglass decreases by 3 to 10 percent. See *Appendix A-3* for the calculation of density and the number of bags needed to achieve the desired R-value at the settled density.

2.2.5 Installing Blown-in Attic Insulation

Blown insulation is preferred over batt insulation because blown insulation forms a seamless blanket. Blowing attic insulation at the highest structurally allowable density helps minimize settling and reduces convective currents within the insulation.

Follow these steps when installing loose-fill attic insulation:

1. Fill the edges of the attic first, near the eaves or gable end and work back toward the attic hatch. Ensure proper insulation density over the exterior top-plates.
2. Install insulation to a consistent depth. Use a stick to level the insulation if necessary.
3. Perform a bag count while blowing to confirm the proper depth and density of insulation is installed.
4. Avoid "fluffing," and maintain an adequate density by moving as much insulation as possible through the hose with the available air pressure. The more the insulation is packed together in the blowing hose, the greater its installed density will be.
5. Fill floored attic cavities to a higher density to minimize settling, if no electrical or material hazards are present. Install dense-packed or maximum structurally allowable density

insulation in floored attic cavities when hidden bypasses have not been addressed by other methods.

6. Add additional insulation over floored attics not used for storage, as needed to achieve the specified R-value.

2.2.6 Installing Attic Batt Insulation

Follow these steps when installing fiberglass batts horizontally in the attic:

1. Install unfaced fiberglass batt insulation. Cut batts carefully to ensure a tight fit against the ceiling joists and other framing.
2. Install two layers of batt insulation at a right angle to each other. This practice minimizes voids and produces better thermal resistance.

2.2.7 Installing Attic Insulation in 1½ Story Homes (Finished Attics)

Finished attics in 1½-story homes require special care when installing insulation. They often include four separate attic sections requiring different sealing and insulating methods:

Collar beam: The attic at the top of the building, which runs between and connects the two roof rafter attics.

Roof rafter: The cavities between the ceiling and the roof. The roof rafter section that runs between the collar beam attic and the top of the knee wall is sometimes referred to as the “slope” or “slant.”

Knee wall: The short wall between the living area and the outside structural wall of the building. The space created behind the knee wall is often used for storage.

Outer ceiling joist: Flat attic surface located above the first-floor living area. Follow these methods when insulating finished attics:

Method A

Method A treats the space behind the knee wall as *unconditioned* attic space. The thermal boundary includes the collar beam, the roof rafter, the knee wall, and the outer ceiling joist.

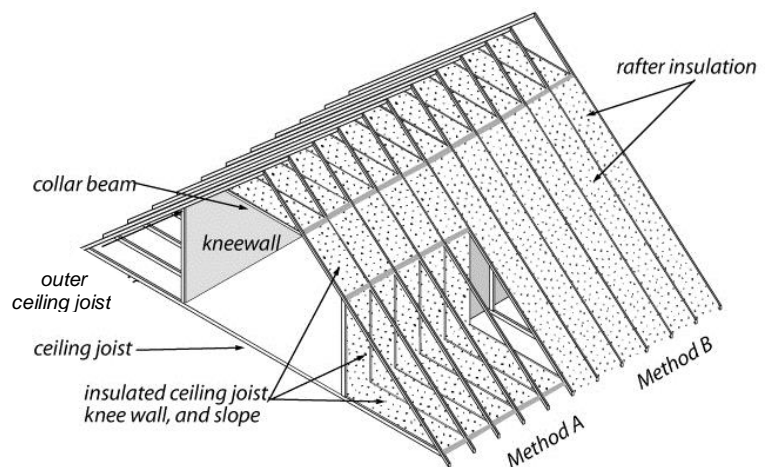

Finished attic: This illustration depicts two approaches to insulating a finished attic. Either A) insulate the knee wall and outer ceiling joist, or B) insulate the rafters. Method A reduces the size of the heating envelope, while Method B results in less surface area exposed to unconditioned air.

Follow these steps to treat the attics using **Method A**:

1. Seal and carefully insulate built-in closets, dressers, or cabinets that protrude into the thermal boundary through the knee wall. Two-part foam can be effective at sealing and insulating these areas from inside the knee wall attic. See *General Information on Spray Polyurethane Foam (SPF) in Appendix A-4* for additional information.
2. Create an airtight, permanent seal in the floor-joist space under the knee wall. Insert pieces of rigid board insulation, drywall, or ductboard in between each joist, and seal the perimeter of each piece with one-part foam; or by inserting a fiberglass batt into the cavity and spraying its face with two-part foam, or by using the **Bag Method** to blow a tight plug of dense-packed cellulose into the joist cavities.

To use the **Bag Method**: place a plastic or mesh bag over the end of the fill tube and insert the tube and bag into the cavity. While holding on to the bag, start blowing insulation into the bag until full, then push the remaining part of the bag into the cavity. The bag will limit the amount of insulation it takes to plug this area.

3. Ensure insulation coverage is adequate where the knee wall meets the roof rafter and where the roof rafter meets the collar beam.
4. Insulate the roof rafters using dense-packed insulation. The roof rafters can be insulated from either the collar beam attic or the outer ceiling joist attic. Ensure the opposite end has a barrier installed. Alternatively, dam both ends of each cavity and blow the roof rafters from the interior, like interior wall insulation. See *Dense-Packed Wall Insulation from the Interior in Chapter 2 – Section 2.3.5*.

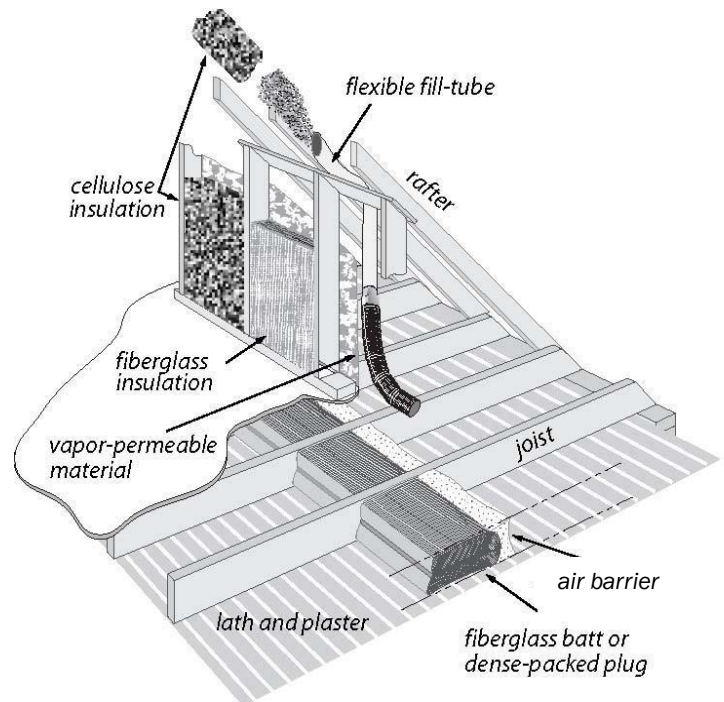

Finished attic best practices: Air sealing and insulation combine to dramatically reduce heat transmission and air leakage in homes with finished attics.

5. Insulate knee walls using dense-packed insulation, fiberglass batts, or two-part foam. If dense-packing the knee walls, prepare for insulation installation by fastening a vapor-permeable material to the cold side of the knee wall studs with reinforcement as needed. If the attic area remains accessible two-part foam insulation must be covered with a thermal barrier.
6. When insulating knee walls with batt insulation, use appropriately sized batts to fit into the stud cavities.
7. Cover existing and/or installed fiberglass batt insulation with a vapor-permeable material to prevent wind wash. Wrap or seal the vapor-permeable material around the studs at each end to prevent air movement behind the material. If a second layer of batt insulation leaves the studs inaccessible, fasten the vapor-permeable material to the roof rafters and deck at the top and to the floor at the bottom of the wall.
8. Insulate attic access panels in the knee wall to the R-value of the adjacent knee wall insulation, or to the maximum structurally allowable, whichever is lower. Operable panels must be weather-stripped and must close with a tight seal, along with securing the attic door using a latch, lock, or frictionally engaging materials. Vertical access panels require mechanical fasteners to maintain a tight seal.
9. Install a dam if needed to maintain the insulation's R-value near the access and to prevent loose-fill outer ceiling joist insulation from spilling into the living area. Secondary access panels in a knee wall may be sealed permanently, with the building owner's approval.
10. Follow steps in *Insulating Attics with Limited Accessibility* in Chapter 2 – Section 2.2.8 for insulating the collar beam and outer ceiling joist attics.



Method B

Method B treats the attic space behind the knee wall as *conditioned* space. The thermal boundary is located at the roof deck and at the gable end walls.

Follow these steps to treat the attics using **Method B**:

1. Create an airtight, permanent seal in the joist space over the top of the first-floor exterior top-plate. This can be done by inserting pieces of rigid board insulation, drywall, or duct board and foaming the perimeter of each piece with one-part foam; or by inserting a fiberglass batt into the cavity and spraying its face with two-part foam; or by using the **Bag Method** to blow dense-packed cellulose into the joist cavities. See **Method A** above for information about the **Bag Method**. See the *General Information on Spray Polyurethane Foam (SPF)* in *Appendix A-4* for additional information.
2. Air seal along the gable end walls. Since the attic will become conditioned space, do not air seal at the floor of the outer ceiling joist, or at the floor-cavity key juncture beneath the knee wall.
3. Ensure insulation coverage is adequate and continuous where the roof rafter meets the outer ceiling joist and exterior top-plate.
4. Insulate the roof rafters and gable ends.
 - a. Dense-pack insulation method:
 - i. Existing sheathing: Drill holes and install dense-pack insulation using tubing method. Patch all drilled holes. The roof rafters can be insulated from the collar beam attic using the tubing method.
 - ii. Exposed studs or rafters: If the cavities are to be dense-packed, prepare them for blowing by fastening a *non-vapor-permeable* material on the warm side of the rafters with reinforcement, as needed. Seal the edges to achieve a continuous vapor retarder. Blow the cavities from the outer ceiling joist attic through holes cut in the *non-vapor-permeable* material. Patch all cut holes. The roof rafters can be insulated from the collar beam attic using the tubing method.
 - b. Batt insulation method: If batt insulation is installed, cover it with a vapor retarder. Air seal the material, since it will now act as the primary pressure boundary.
 - c. Two-part foam method: If two-part foam is installed, do not install a vapor retarder, since two-part foam acts as both insulation and as an air seal. Typically, two-part foam insulation costs more than installing dense-packed cellulose or air sealing and then installing batts. If the side attic is to remain accessible, the foam must be covered with a thermal barrier.
5. Follow steps in *Chapter 2 – Section 2.2.8* for insulating the collar beam attic.



Method B, using foil-faced polyiso foam board as vapor barrier and air barrier.

2.2.8 Insulating Attics with Limited Accessibility

In attics with limited access and no electrical or material hazards are present, insulate with loose fill insulation to a sufficient density to minimize settling. Install dense-packed insulation in inaccessible attic cavities when hidden bypasses have not been addressed by other methods.

These areas may include, but are not limited to:

- ✓ Shed style roof
- ✓ Inaccessible collar beam attic
- ✓ Inaccessible outer ceiling joist attic and knee wall areas

When insulating attics with limited access:

1. Inspect the roof to verify it is in good condition, without visible deterioration.
2. Access the cavity through the gable ends, rafter tails, roof deck, or through the ceiling.
3. Inspect the attic for any air bypasses to the conditioned space. Seal discovered bypasses as directed in *Air Sealing and Indoor Air Quality in Chapter 1 – Section 1.4*.
4. Install blown-in insulation using an appropriate method.

2.2.9 Insulating Closed Roof Cavities

Insulate closed roof cavities with loose fill insulation at a sufficient density to minimize settling, if no electrical or other hazards are present. Install dense-packed insulation in attic cavities when hidden bypasses have not been addressed by other methods.

These areas may include, but are not limited to:

- ✓ Cathedral roof
- ✓ Flat roof
- ✓ Dormers
- ✓ Above bump-outs

When insulating closed roof cavities:

1. Inspect the roof to verify it is in good condition, without visible deterioration.
2. Access the cavity through its gable ends, rafter tails, roof deck, or through the ceiling.
3. Blow the insulation using an appropriate method to ensure proper density of installed insulation.

2.3 Wall Insulation

Properly installed dense-packed wall insulation reduces air leakage through walls and other closed building cavities because the fibers are driven into the cracks by the blowing machine.

Empty or partially empty wall cavities encourage air flow like chimneys. Convection currents or air leakage can significantly reduce wall insulation's thermal performance if spaces remain for air to flow. Installing dense-packed wall insulation with uniform coverage and density is important. The tube-fill dense-pack method is Wisconsin's chosen wall insulation method because it ensures adequate coverage and density of insulation.

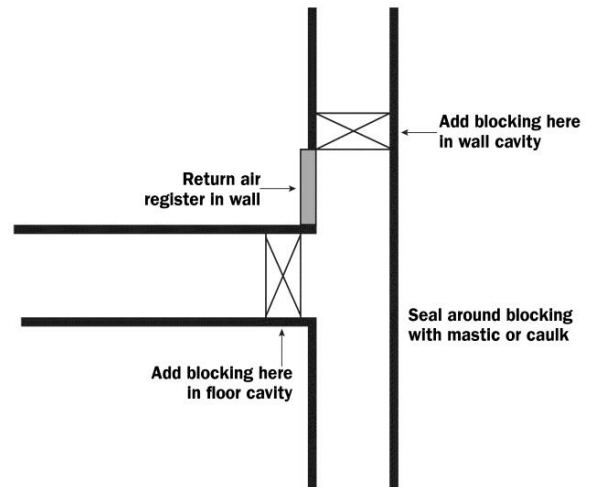

Caution is necessary when tube-filling walls because the process puts pressure on the interior and exterior wall surfaces. If the pressure becomes too great on a particular material — such as plaster, drywall, or paneling — the wall could crack or burst. It is also important to check for hidden holes in exterior walls and balloon framed structures where insulation can escape into basements, attics, closets, and other spaces. Inspect exterior walls to identify cavities that are open to, contain, or are part of the forced-air distribution system. Seal distribution systems in cavities to be insulated. Use extreme care to ensure insulation does not fill wall cavities that are part of the distribution system, which may result in damage to the furnace.



Infrared scanner: Allows the user to see temperature differences, which verify insulation coverage in a wall cavity.

Adequate insulation coverage and density of insulation may be confirmed using an infrared camera or laser thermometer or by using a blower door with artificial smoke. Whenever possible, use these tools to verify complete insulation coverage.

Uninsulated and poorly insulated parts of the wall will display differently on an infrared camera than a well-insulated wall. The tool is best used whenever a substantial temperature difference exists, or can be created, on either side of the wall.

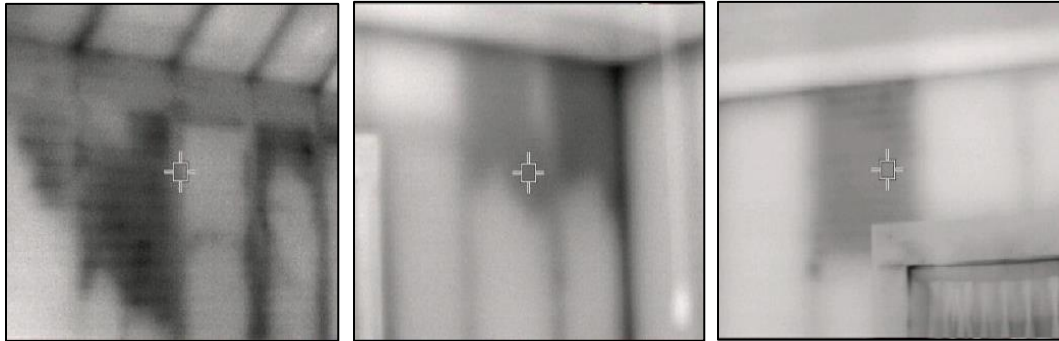

Infrared images of exterior surfaces: Dark patches indicate areas with little or no insulation – either insulation voids or framing members.

When cavities are packed to the proper density, chemical smoke will not be seen to move through penetrations, even when the building is brought to a pressure differential of 50 pascals.

2.3.1 Calculating Wall Coverage and Density

Dense-packed wall insulation should be installed to a density of 3.5 to 4.5 pounds per cubic foot for cellulose, and 2.0 to 2.5 pounds per cubic foot for fiberglass. These calculations serve to determine the number of bags necessary to insulate walls and to judge density after completing the wall insulation job. See *Appendix A-3* for the calculation of density and the number of bags needed to achieve the R-value at the settled density.

2.3.2 Inspecting and Repairing Walls Before Installing Insulation

1. Inspect walls for evidence of moisture damage.
2. Seal obvious gaps in external window trim or other areas that may permit the penetration of water into the wall.
3. Before removing siding, detach any clamps that secure gutters and electrical conduit, etc. to the exterior siding.
4. Inspect indoor surfaces of exterior walls to ensure they are strong enough to withstand the force of dense packing. Temporarily reinforce or permanently repair weak walls where necessary, prior to dense packing.
5. Inspect for interior openings from which insulation may escape, such as pocket doors, un-backed cabinets, interior soffits, closets, and balloon framing openings in the attic or crawl space. Taking a few minutes to investigate these areas will save a lot of time and mess later, if openings do exist. Seal openings as necessary to prevent blown insulation from escaping.
6. Do not insulate cavities used as forced-air distribution. Also, do not insulate cavities containing live knob-and-tube wiring, bare wires, open junctions, or unboxed wire connections. In the customer file, document the location of cavities used as distribution and with live knob-and-tube wiring. See *Electrical Safety in Chapter 5 – Section 5.7*.

2.3.3 Removing Siding and Drilling Sheathing

When insulating a wall from the exterior, remove the outer layer of siding to drill through sheathing and any sub-layers of siding. Removing the siding may make it easier to insert a flexible fill tube, since the tube must pass through one less layer of material. Carefully removed and handled siding is reinstalled after insulating, creating an appearance as close to the original as possible. Drill holes through siding (with building owner's consent) only as a last resort and only if siding cannot be removed. Documentation must be in the customer file detailing the conditions that precluded the removal of the siding.



Some siding materials require specialized procedures. Cement- asbestos board (transite, also called slate siding), and stucco may only be disturbed by persons with appropriate Department of Health Services (DHS) asbestos certification (see Wisconsin Weatherization Program Manual, Chapter 9 – Health & Safety for complete asbestos policy). Sidewall insulation procedures should follow lead-safe procedures under the direction of a Lead Safe Renovator when applicable (see Wisconsin Weatherization Program Manual, Chapter 9 – Health & Safety for complete lead policy). Any person who completes this work must be trained in lead-safe procedures.

1. Metal or vinyl siding may be removed with a zip tool.
2. Lap siding requires careful prying with a flat bar underneath the nails that fasten the siding to the framing. Cut the paint between pieces of siding with a utility knife before prying.

For more information regarding siding removal, refer to “Dense-Pack Sidewall Insulation” video, available on the HE Plus TTA website.

Removing metal or vinyl siding: A zip tool separates joints in vinyl and metal siding.

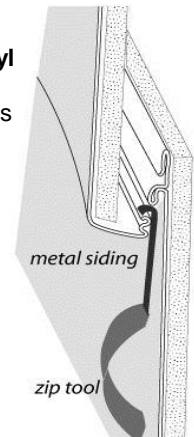

2.3.4 Dense-Packed Wall Insulation from the Exterior

Dense-packed wall insulation is best installed using the tube method with an insulation blower equipped with separate controls for air and material feed. Mark the fill tube in one-foot intervals so the installer knows when the tube has reached the top of the wall cavity and when the end of the tube is almost removed upon completion of dense-packing the cavity.

Insulation hoses, fittings, and the fill tube: Gradual reductions in the hose diameter will reduce the chance of plugging the hose with insulation. The goal is to achieve a material to air mixture that maximizes production and correct density.



To prevent settling, loose-fill insulation must be blown at the recommended density of 3.5 to 4.5 pounds per cubic foot for cellulose and 2.0 to 2.5 pounds per cubic foot for fiberglass.

To insulate sidewalls from the exterior:

1. Remove siding, following lead-safe practices if required. See *Lead Paint and Lead-Safe Work in Chapter 5 – Section 5.5*. Transite (slate) siding shall be removed intact only by persons with appropriate DHS asbestos certification, unless the siding has been tested and does not contain asbestos.
2. Drill or cut a two- to three-inch diameter hole to access each cavity to be insulated.
3. Probe all wall cavities through holes, to identify fire blocking, diagonal bracing, and other obstacles. After probing, drill or cut whatever additional holes are necessary to ensure complete coverage.
4. Start by insulating several full-height, unobstructed wall cavities with a known quantity of insulation so the installed density can be calculated and the blower controls can be set properly.
5. Depending on the location of the hole, insert the tube all the way to one end of the cavity. Start the machine and back the hose out slowly as the cavity fills. Work the hose back and forth in the cavity to pack the insulation tighter, if necessary.
6. Shut off the flow of material when approximately one foot of tube is remaining in the wall. Re-insert the tube to the opposite end of the cavity, and repeat Step 5. Shut off the flow of material when the cavity is completely full.

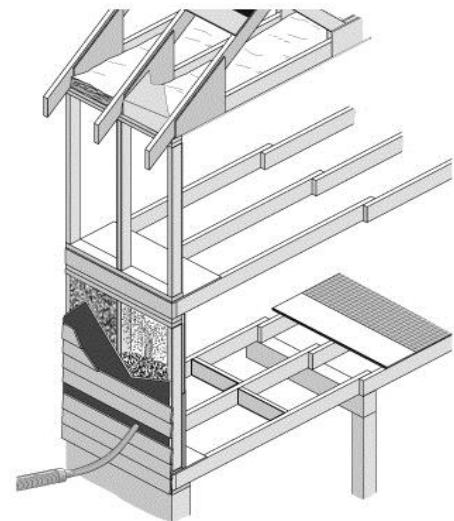

Tube-filling walls: This method can be accomplished from inside or outside the home. It is the preferred wall insulation method because it is a reliable way to achieve a uniform coverage and density.

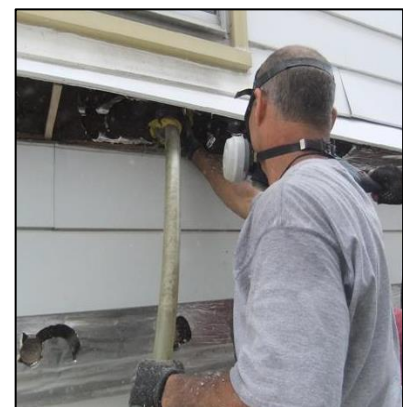

Tube-filling walls: Insulation is dense-packed into walls using a fill tube inserted into the wall cavity.

7. Plug the holes, seal the plugs to prevent water and air infiltration, and replace the siding.

When insulating balloon framed walls or the band joist areas on multi-story buildings, insulate the perimeter between the two floors by blowing insulation into each floor cavity to create an insulation plug. This technique also prevents air movement through the floor cavity.

If the process is requiring too much insulation, use the **Bag Method**. See *Method A in Chapter 2 – Section 2.2.7* for information about the **Bag Method**.

2.3.5 Dense-Packed Wall Insulation from the Interior

In homes where the walls cannot be insulated from the exterior, insulating from the interior may be necessary. Holes drilled for insulation must be returned to an appearance as close to original as possible, or so the result is satisfactory to the customer.

To insulate sidewalls from the interior:

1. Practice lead-safe work techniques. See *Lead Paint and Lead-Safe Work in Chapter 5 – Section 5.5*.
2. When testing results require, follow asbestos protocols. See Chapter 9 (Health & Safety) of the Wisconsin Weatherization Program Manual for comprehensive asbestos policies.
3. Remove the baseboard or chair rail when possible to allow drilling. Use wood or foam plugs and joint compound or quick-setting plaster to seal the holes before re-installing the baseboard or chair rail. Or, drill holes and stagger them by at least six inches up and down, which will reduce horizontal cracking in lath-and-plaster walls.
4. Use a non-conductive probe to determine where to drill into the next cavity.
5. Insert a fill tube, and dense-pack the cavity following the procedures detailed in *Dense-Packed Wall Insulation from the Exterior in Chapter 2 – Section 2.3.4*.
6. Use wood or foam plugs along with joint compound or quick-setting plaster to seal and patch the holes.
7. Chair rail or wallpaper trim can be installed to conceal the holes if necessary.

2.3.6 Dense-Packing from Other Access Locations

Balloon framed cavities can often be insulated from either the attic or basement where the cavity is open. In these cases, use a temporary dam to completely fill the cavity with dense-packed insulation, following the procedures described in *Installing Attic Insulation in 1½-Story Homes (Finished Attics) in Chapter 2 – Section 2.2.7*.

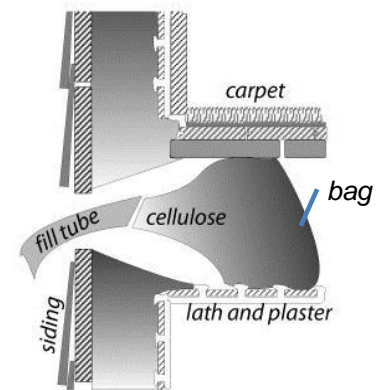

Plugging a balloon framed floor cavity: Blow a plug of insulation into balloon framed second-floor cavities.

2.3.7 Interior Open-Cavity Wall Insulation

Fiberglass batts achieve their rated R-value only when installed correctly. If gaps exist between the cavity and batt at the top and bottom, or if the batt is compressed, the effective R-value can decrease by as much as 30 percent. Fiberglass insulation must have a flame spread and smoke development index of 24/450 or less and backing material with a smoke development index of 450 or less when tested in accordance with ASTM E84 or UL 723.

To insulate open interior-wall cavities:

1. Prior to installing insulation, air seal the exterior wall sheathing.
2. Use appropriately sized, unfaced friction-fit fiberglass batt insulation where possible.
3. Choose high-density batts whenever possible and install to the maximum structurally allowable.
4. Install the batt to fill the entire cavity, without spaces at the corners or edges.
5. Cut batt insulation to the exact height of the cavity. A short batt creates air spaces above and beneath the batt, allowing convection. A long batt bunches up, creating air pockets.
6. Split batts around wiring, rather than letting the wiring bunch the batt to one side of the cavity.
7. Insulate behind and around obstacles with scrap pieces of batt.
8. Prior to installing drywall, cover exposed unfaced insulation with an airtight polyethylene vapor retarder. Install the vapor retarder to the warm side of the wall.
9. Kraft- or foil-faced insulation exposed to the interior living space must be covered with a thermal barrier such as a minimum half-inch gypsum board.

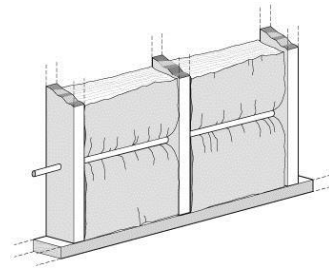

Fiberglass batts compressed by a cable: This reduces the wall's R-value by creating a void between the insulation and interior wallboard.

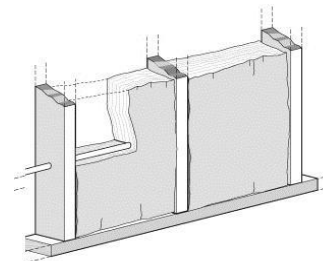

Batt split around a cable: The batt attains its rated R-value.

Dense-packed insulation may sometimes be blown into open stud cavities through an air barrier or plastic mesh. This is a good option if the insulation is packed densely enough to resist settling. The mesh will bulge if installed at the proper density; however, it could hinder drywall installation. Instead, consider cutting holes in the drywall to tube-fill the cavities with dense-packed insulation after installing drywall.

2.4 Crawl Space Requirements

Crawl spaces are usually small and difficult areas to complete work. Agencies should have a written policy for the minimum working requirements to effectively complete the necessary work in a crawl space.

2.4.1 Crawl Space Access Requirements

When creating new access to a crawl space, the following access sizing guide should be implemented:

Access Type	Size
Floor access	18" x 24"
Perimeter wall access	16" x 24"

A new access may need to be smaller if the existing framing members constrain work. Do not disturb framing or structural systems to install the access hatch.

2.4.2 Crawl Space Signage

A laminated sign, at least 8½" x 11" in size, should be posted at every access, inside of the crawl space. The sign will include the following information:

- ✓ List of mechanical components installed in the crawl space.
- ✓ Statement prohibiting the storage of hazardous and flammable materials.
- ✓ Caution statement for those entering the crawl space not to damage the air barrier, ground vapor retarder, and/or insulation.
- ✓ Installer contact information will be included on the sign in case there are questions or need for repairs.

2.5 Floor and Foundation Insulation

Insulation and air sealing of the foundation combine to complete the thermal boundary at the base of the building. As parts of the foundation are identified and defined as inside of the thermal and pressure boundaries, it is very important to ensure exposed soil is covered with a ground vapor retarder. Assess the crawl space ground area for health and safety issues and debris. Remove any vegetation or items greater than one inch that might penetrate through the ground vapor retarder or cause injury. Properly dispose of any identified items.

Install a ground vapor retarder in accordance with the SWS section 2.0202 (minimum 6 mil in thickness of 0.1 perm or less) over exposed earth. Install a thicker ground vapor retarder if items are present in the crawl space that could reduce the effectiveness and durability of the barrier. Overlap the seams of the ground vapor retarder a minimum of 12 inches with a “reverse shingle” or “upslope lapping” technique (e.g., overlapping so water leaking through the foundation wall will not flow in between the seams). Seal all seams, and around all penetrations. Install the wall vapor retarder under the ground vapor retarder at the wall to floor connection. The air barrier and ground vapor retarder should not interfere with the established drainage pattern. Interior drainage collection points must remain accessible. Secure the ground vapor retarder with fasteners or ballasts on sloping ground or if the area is routinely used for maintenance or storage to avoid uplift. All penetrations in the ground vapor retarder along with seams and connections to the foundation must be sealed with a durable and compatible sealant.

Ensure the ground vapor retarder is not damaged when installed or when performing work. Seal holes and rips with the appropriate materials if it is damaged in the work process.

If an existing drain is present, the installed ground vapor retarder should not prevent flow of moisture to the drain.

The choice between insulating the floor or the foundation should be made based on accessibility and if heating distribution or plumbing runs through the area. Basements are generally not insulated during weatherization, but sealing is typically required to stop air infiltration. For other considerations, see *Locating the Pressure/Thermal Boundary in Chapter 1 – Section 1.5.3*.



Insulating and air sealing rim joist: Rigid board insulation installed in joist cavities, with spray foam to seal at the edges.

2.5.1 Establishing a Thermal Boundary

To establish an effective thermal boundary, the insulation and air barrier should be adjacent to each other, with the air barrier located between the insulation and the conditioned space.

In most northern climates, the preferred method is to insulate and air seal the foundation walls and not the floor. This includes sealing crawl space vents. This strategy encloses the furnace, ducts, pipes, and other features within the thermal and pressure boundaries.

2.5.2 Rim Joist and Box Sill Insulation

The joist spaces at the perimeter of the floor can be a weak point in the thermal boundary. Insulating both the rim joist and longitudinal box joist are appropriate either as individual procedures or as part of floor or foundation insulation.

Air seal stud cavities in balloon framed homes as a part of insulating the rim joist. If the box sill will be insulated, two-part foam can be useful as it insulates and air seals in one application. One primary advantage of two-part foam is its ease of installation in areas of limited accessibility. Follow the foam manufacturer's installation instructions and applicable building codes when installing two-part foam. Before applying spray foam, ensure the substrate is dry and reasonably clean. Do not apply more than 3 inches of spray foam in the box sill area. Two-part spray foam shall be installed at a density of 0.5-2.0lb/ft³. SPF installed below the sill box requires a thermal barrier from the interior of the dwelling.

Use appropriate personal protective equipment (PPE) when installing two-part foam. Follow the manufacturer recommendations for safety precautions. See *Personal Protective Equipment in Chapter 5 – Section 5.1* and the *General Information on Spray Polyurethane Foam (SPF) Appendix A-4* for additional information.

Rigid board insulation is also good for insulating and air sealing the rim joist area. If foam board is used to insulate the rim, spray foam can be used to seal around the edges. Longitudinal box joist cavities, enclosed by a floor joist, may be sealed and blown with wall insulation unless there is evidence of a moisture problem in the area. If the insulation will be in direct contact with the foundation, cellulose insulation should not be used to prevent potential moisture issues.

Use faced fiberglass batt insulation with caution. Air can circulate around the fiberglass, causing condensation and encouraging mold on the cold rim joist. Fiberglass batts may be used to insulate the rim joist only when:

1. The box sill is effectively air sealed.
2. The batts are cut to the proper size and completely fill the cavity.

2.5.3 Floor Insulation

Prior to insulating the floor, take all appropriate measures to establish an effective air barrier at the floor, in order to prevent air from passing through or around floor insulation.

Insulating Open Floor Cavities

Install a ground vapor retarder that runs up the foundation walls at least six inches in crawl spaces. Seal the ground vapor retarder to the foundation wall with appropriate material and seal all penetrations.

Caution: Vapor retarders are typically for use in crawl spaces. In basements, restrict their use to basements with dirt floors and limited access. If the ground vapor retarder is installed in a seldom-used basement, install walk boards to prevent residents from slipping. Problems such as plumbing leaks or bad site drainage must be addressed prior to installing the barrier, to avoid water pooling on or under the barrier.

Complete the following when insulating open floor cavities:

1. If the walls are balloon framed, contain wall insulation by air sealing the bottoms of the stud cavities prior to installing floor insulation.
2. Install the maximum thickness of insulation between floor joists that the structure allows. Fill the entire joist space if possible. Fit floor insulation tightly against the subfloor and the rim joist to reduce air convection.
3. Install insulation without voids, edge gaps, or end gaps. Fit insulation closely around cross bracing and other obstructions.
4. Securely support batt insulation within each cavity with insulation hangers, plastic mesh, a vapor-permeable air barrier, or other supporting material.
5. Seal and insulate ducts remaining in the crawl



space or unoccupied basement. See *Forced-Air Furnace Air Distribution in Chapter 3 – Section 3.4* for information on sealing and insulating ductwork.

6. Consider installing a vapor-permeable air barrier to prevent convective looping, support the insulation, and keep pests out.

Insulating Enclosed Floor Cavities

Install dense-pack insulation in floor cavities. Confirm the cavities are enclosed by rigid sheeting. This method works well in garage ceilings, cantilevered floors, and beneath bay windows.

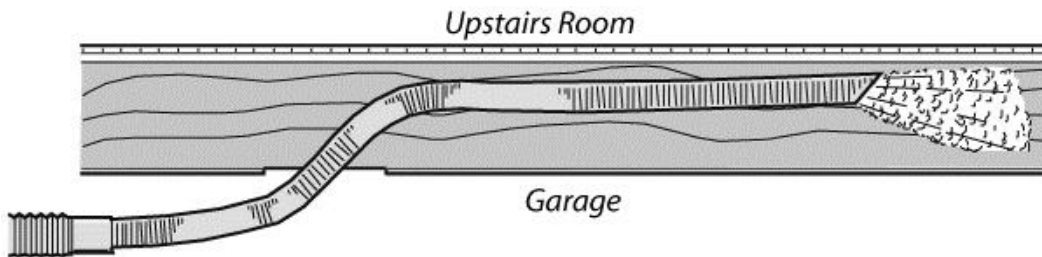

Blowing a garage floor cavity: Uninsulated floor cavities can be insulated with blown fiberglass or cellulose insulation, using a fill tube.

2.5.4 Foundation Insulation

Foundation insulation is usually installed on the inside of the foundation wall. Less frequently, foundation insulation is applied from the home's exterior. Where termite pressure may exist, removable band joist insulation will be installed while maintaining a 3" inspection gap from the top of the insulation to the bottom of any wood.

Interior Foundation Insulation

1. Attach insulation to the inside wall surface with appropriate fasteners and/or adhesive. Install insulation with no significant voids or edge gaps.
2. Foil Scrim Kraft (FSK) fiberglass insulation should be attached to the sill plate, floor joists, and/or floor. Insulate the rim joists with unfaced fiberglass before installing the FSK-faced insulation to prevent a void behind the FSK insulation at the rim joist.
3. Securely attach extruded or expanded polystyrene or foil-faced polyisocyanurate insulation boards when installed on flat foundation walls.

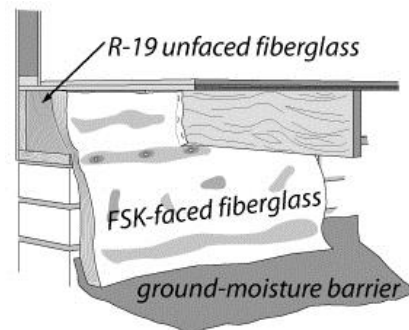

Fiberglass foundation insulation: Use this method only in dry conditions where the drainage outdoors is effective.

4. Spray two-part foam on the interior surface of the foundation to maintain the required insulation level. This may require application of more than one coat to ensure full curing of the material. Take proper precautions for the safety of the crews and occupants during installation. Follow the manufacturer's recommendations for application and for safety equipment to be used. Follow all applicable building codes. When applied correctly, two-part foam will insulate and air seal the foundation. Typically, two-part foam expands to twice the thickness of the initial application, so be careful not to over-insulate. See the *General Information on Spray Polyurethane Foam (SPF) in Appendix A-4* for additional information.

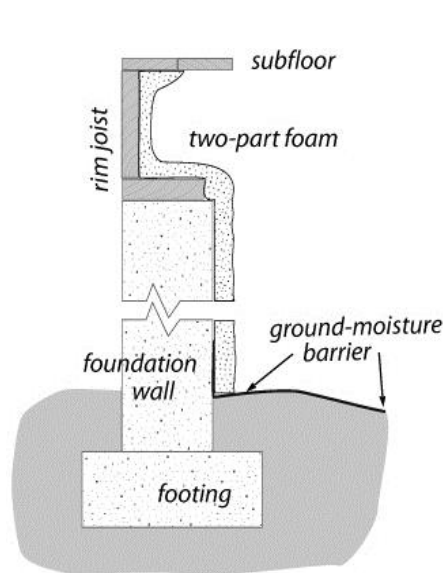

Foam-insulated crawl space:
Two-part foam insulates and seals the rim joist as well as insulating the foundation walls.

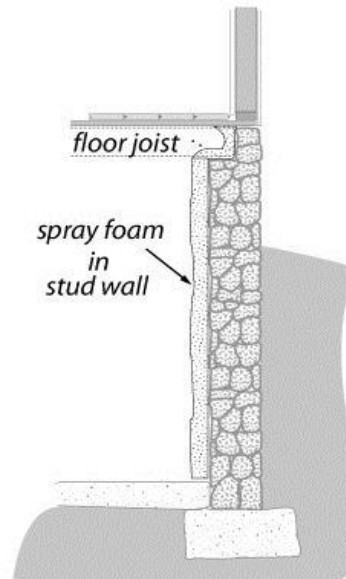

Two-part foam sprayed on rubble masonry: Rubble masonry walls can be insulated on the interior with sprayed foam.

5. In cold weather, apply a skim-coat of foam first, before fully spraying the wall. The skim-coat will heat up the wall, which will help the foam adhere to the wall.
6. When two-part foam is used, a thermal barrier (e.g., ½" gypsum wallboard) as specified by applicable building code and manufacturer specifications is required to separate the foam plastic from the living and storage areas. Thermal barriers can be applied to a wall that separates crawl space insulation from a basement. An ignition barrier covering or coating applied according to manufacturer specifications can be used if the space is used only for the service of utilities. For buildings with only a crawl space, the plywood flooring serves as the separation.
7. Attach outside access hatches securely to the foundation wall, latched and weather-stripped. The hatch should be lockable. Insulate the hatch only when it is part of the thermal boundary.

Exterior Foundation Insulation

1. Install exterior foam insulation to a minimum depth of six inches below grade, unless restricted by non-excavatable ground, such as a sidewalk. Apply a durable covering or coating to the entire surface of the insulation, including joints and corners.
2. Completely cover the exposed foundation with insulation.
3. All connecting joints must form a seal or be sealed with appropriate sealant.
4. If the insulation is not protected by the siding, install a drip edge.

Final Inspection and Quality Assurance Standards

Acceptable installations shall meet the following standards.

Attic Insulation

Attic Insulation Storage Area

1. The storage area is as small as possible and still meets the homeowner's needs.
2. Floor plugs installed if needed.
3. The insulation installed beneath the storage area is installed to the R-value specified by the computerized energy audit.
4. The storage area presents no hazards to occupant.
5. Items in the storage area were protected from insulation.
6. Floorboards were re-installed properly.

Damming

1. The box is higher than the surrounding insulation and does not interfere with opening the access.
2. The box is effective in performing its specified function.
3. When necessary, the box is constructed of non-combustible material.
4. The chimney box is at least three inches from an active chimney or per manufacturer's instructions.
5. Active chimneys meet chimney guidelines (e.g., no cracking, no creosote present, structurally sound, etc.).

Attic Access

1. Allows for repeated access to attic.
2. All trim is properly sealed and weather-stripped.
3. Access panel is insulated to same R-value as the attic or the maximum structurally allowable, whichever is lower.
4. Access is covered with an appropriate fire-rated material (as required by code).
5. Insulation certificate is completed and placed near an attic hatch or in another visible location such as near an electrical panel.

Attic Bypass Sealing

1. Bypasses are sealed to the level called for under Wisconsin's Weatherization Program requirements.
2. Bypasses are sealed with an appropriate material and amount of material.
3. All equipment mounted in the ceiling is properly air sealed.

Roof Leaks

1. No visible evidence of roof leaking is present.

Attic Wiring

1. All electrical boxes are covered, sealed, and flagged if concealed by insulation.
2. All live knob-and-tube wiring is boxed out prior to insulation maintaining a three-inch clearance around the wires, the boxing ends are sealed, the boxing is flagged with caution tape that is visible from at least five feet away, and appropriate signage is posted.
3. Rewired (permit pulled, if applicable) and inspected (if required).

Heat Producing Products (lights, chimneys, flues, attic furnaces, and non-IC rate fixtures)

1. Boxing is a minimum of three inches from device. Boxing material is gypsum wallboard, cement board, or other code-approved material.

Exhaust Fans and Vent Stacks

1. Vents will exhaust the specified area to the outdoors.
2. Stacks are properly sealed at intersection with building materials.

Attic Vapor Retarders

1. Installed correctly toward the warm side.
2. Installed in continuous manner, with edges sealed.

Attic Venting

1. Allows air to pass through vent.
2. 40-50% of installed vents are within 3 feet of the highest point in the vented space.
3. Vents are made of corrosion-resistant material appropriate for their specific location.
4. Vents have screens with non-corroding wire mesh with openings of $\frac{1}{16}$ " to $\frac{1}{4}$ " to prevent pest entry (e.g., birds, bats, and bees).

Attic Floor Insulation, Open Blow

1. Installed to the R-value selected by the audit.
2. Insulation is installed to a uniform R-value, with no variances of greater than two inches.
3. All wiring is properly flagged, no bare wiring, junction boxes have covers.
4. Live knob-and-tube wiring is properly dammed, maintaining 3-inch clearance to insulation.
5. Insulation depth markers are in place.

Attic Cavities (site-built)

1. All areas specified are insulated.

Knee Wall Attic Walls

1. All cavities are filled with insulation to the maximum structurally allowable, with no voids present.
2. The vapor permeable air barrier seams and edges are sealed, and it is mechanically fastened.

Sidewall Insulation (site-built)

1. All cavities are properly insulated to the maximum allowable amount and proper density. When cavities are dense packed to reduce air leakage, artificial smoke does not move through penetrations when the building is pressurized to 50 pascals.
2. Blown insulation is installed from the exterior or the attic unless limited by the building structure or health and safety issues, with prior approval of the building owner.
3. Based on file documentation (photos), work has been completed in a lead-safe manner.
4. All siding that is suspect ACM has been addressed under the supervision of a competent person.

Sidewall Wiring

1. All hazards are addressed prior to insulating.

Floors Over Unheated Areas (site-built including cantilevers)

1. Insulated to the maximum structurally allowable. When cavities are dense packed to reduce air leakage, artificial smoke does not move through penetrations when the building is pressurized to 50 pascals.
2. Vapor-permeable air barriers may be used on the cold side of the insulation.
3. Weather and pest-proof cover between cantilever insulation and the outside.

Box Sill Insulation

1. Area is sealed and filled to the R-value selected by the audit.

Interior Foundation Insulation

1. Area is insulated to the R-value selected by the audit.
2. If two-part foam is installed, there must be a thermal barrier between the area of application and living area of the building, including in unintentionally heated basements.
3. Continuous ground vapor retarder covers all exposed soil surfaces and is sealed to the

wall. A minimum of a 12-inch overlap of seams is maintained using the reverse or upslope lapping technique. The ground vapor retarder is fastened down using durable fasteners or ballasts in areas routinely used for maintenance or storage or where sloping ground exists to avoid uplift. All seams, penetrations, and connections to the foundation are sealed with a durable, compatible sealant.

Exterior Foundation Insulation

1. A minimum of R-5 insulation installed.
2. NEAT documentation in the file.
3. Depth of the insulation is at least six inches and not greater than 14 inches.
4. Material has protective coating at least six inches below grade.
5. An effective drip edge makes a positive seal between the foundation and the wall assembly.

Chapter 3: Heating System Measures

3.1 Heating and Cooling Systems

This chapter covers improvements to heating and cooling systems. The improvements include the replacement or the modification and repair of the appliance. Complete combustion safety testing for all systems and steady-state efficiency (SSE) testing on gas and oil heating systems. All heating and cooling systems work shall be completed by qualified professionals.

3.2 General Heating System Replacement

All replacement heating systems, except for wood space heaters, shall meet the minimum efficiency standards as specified in the Wisconsin Weatherization Program Manual and listed in the AHRI Directory of Certified Product Performance. Wood heater installation shall conform to the requirement of NFPA 211. Observe the following standards for heating system replacement:

1. Disconnect refrigerant lines, plumbing, ducts, electric, control wires, vents, and fuel supply, when applicable.
2. Install heating systems in accordance with manufacturer's instructions and applicable state and local codes.
3. Use existing distribution system and fuel supply line, when possible.
4. Properly remove and dispose of existing unit.
5. Provide an owner's manual with heating system replacements on or near the heating system. The manual shall be attached in a durable device that allows for repeated customer access.
6. Properly size replacement heating systems units using an accurate analysis through REScheck, ACCA Manual J, or an equivalent industry-accepted sizing procedure by calculating the heating loads based on the post-retrofit dwelling characteristics.
 - a. When sizing boiler systems, consider the capacity of the existing terminal devices and whether or not domestic hot water will be heated with the boiler.
7. Install gas pipe that is supported and electrically bonded (if required) in accordance with NFPA-54 and the WI Uniform Dwelling Code. Follow the manufacturer's specifications for installation. For more information see NFPA 54 and WI SPS 323.16.
 - a. When CSST is already present in the building and not correctly bonded, bond the gas piping system to the electrical ground in accordance with NEC 250.94 and 250.104 when completing work on the fuel supply and/or the heating system.
8. New heating systems require a dedicated electrical circuit rated or fused to match the amperage of the system's requirements for overcurrent protection. Condensate pumps are allowed to be on the same circuit.
9. Verify and adjust, if necessary, so flue-gas oxygen, stack temperature, and carbon monoxide levels are within manufacturer's specifications. If manufacturer's specifications are not available, refer to *Table 3-2* or *Table 3-5*.

10. Verify and adjust, as needed, to ensure tested SSE meets or exceeds rated AFUE of heating system.
11. Install condensate tubing or piping to reach an appropriate drain. Utilize a hose protection ramp (trip strip) instead of a condensate pump where feasible.
12. Install a condensate pump when the condensate tubing will not drain adequately to an appropriate drain or may cause a tripping hazard. See *Condensate Removal in Chapter 3 – Section 3.8.2* for more information about condensate pumps.
13. Seal openings in chimneys where natural-draft or fan-assisted appliances are eliminated. Indicate with a written notice on the chimney, where sealed, that the chimney is no longer functional.
14. Ensure all remaining naturally vented combustion appliances are drafting properly.
15. Test the heating system's safety mechanisms to confirm they are operating properly and per the manufacturer's specifications (e.g., blower compartment's safety switch and emergency heat circuit are functioning, etc.).
16. Provide in-home operation and maintenance instructions, including a review of safety precautions to the customer.
17. Affix a tag, displayed prominently, identifying who the customer should call for service to the heating unit. The tag information shall contain the name, address, and telephone number of the service organization as well as the date of installation.
18. WHEN A HEATING SYSTEM IS LOCATED IN A CRAWL SPACE: Complete and inspect all heating system work before performing any other measures in the crawl space.

3.3 Forced-Air Furnace Replacement

Observe the following standards specific to forced-air furnace installation:

1. Set fan speed and fuel input for optimal occupant comfort within the manufacturer's temperature rise limits.
2. Perform all required tests and document results.
3. Seal holes through the jacket of the air handler with mastic or foil tape that is UL181 listed.

3.4 Forced-Air Furnace Air Distribution

Forced-air duct systems present opportunities for saving energy in homes. Ducts waste energy through air flow problems, and from air leaks and lack of insulation when they pass through unconditioned spaces. This section addresses these forced-air distribution problems.

3.4.1 Duct System Modification

If adjusting the fan speed and gas pressure does not bring the furnace temperature rise within

manufacturer's specifications, duct work modifications may be considered. Ductwork runs installed to provide heat to individual spaces shall be as short as possible. The placement of a register shall be where it is least likely to be blocked by furniture or other obstacles.

If possible, a single return air grille shall be provided to a central location on the main floor that is heated, with the shortest ductwork run possible. If another floor is heated that can be closed off from the main floor, an additional return air grille may be installed with the shortest ductwork run possible to a central location. This may not apply to a basement when backdrafting or other health and safety risks or efficiency issues are present.

1. Design new ducts in accordance with ANSI/ACCA Manual D and manufacturer's specifications.
2. Design terminations in accordance with ANSI/ACCA Manual T and manufacturer's instruction.
3. Do not add supply registers to the combustion appliance zone (CAZ) unless it is an intentionally heated space. Consult with the customer about removing existing grilles in the CAZ. If grilles are removed, document the customer consultation in the file.
4. Mechanically fasten supply and return ductwork with screws. Seal the ductwork to the furnace cabinet with mastic and fabric mesh tape, caulk, or other UL 181-approved material, to form an essentially airtight connection on all sides of these joints.
5. Do not install new ductwork in unconditioned spaces unless necessary. If ducts are located in unconditioned spaces, seal the joints and insulate the ducts to a minimum of R-8. Ductwork exposed to the exterior of the building shall be insulated to a minimum of R-12.
6. Connect new ducts to the existing distribution. Install a balancing damper in each new branch supply duct. Install registers to terminate each new supply or return branch duct.
7. Do not use building spaces, like basements or crawl spaces, as a plenum or duct.

3.4.2 Duct Leakage

Leaky ductwork poses multiple problems: it may affect the occupants' health and safety, comfort, and the home's energy consumption.

Seal all heating and cooling ductwork that runs outside the dwelling's heated envelope. These duct leaks waste energy and introduce health and safety hazards.

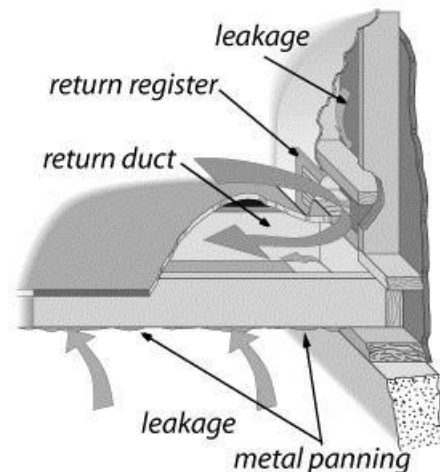

Panned floor joists: These return ducts are often very leaky and may require removing the panning to seal the cavity.

In the CAZ, return ductwork leakage causes depressurization and increases the possibility that natural-draft appliances will backdraft. Supply side leaks in the CAZ are less likely to cause

backdrafts; rather, they may aid the appliances' natural draft by adding positive pressure to the room.

Duct leakage that occurs inside the heated envelope is less likely to contribute to increased energy consumption. Supply duct leakage to outside can introduce excessive moisture into unheated spaces and depressurize the CAZ. Return duct leaks from unheated spaces can draw pollutants into the distributed air causing health issues for the occupants in the home.

Follow these instructions when sealing ductwork:

1. Seal all ducts located outside the thermal boundary. Test for leakage at each register or grille using a pressure pan with house at a 50-pascal pressure difference. Target goal is measured pressure of less than 1 pascal at each opening.
2. Seal the connection between the furnace and the supply plenum, as well as the connection between the furnace and the return drop.
3. Seal all gross holes in the supply and return ductwork. Repair/replace missing ducts in the return and supply systems.
4. Seal return and supply leaks as needed based on guidance in the Diagnostic Workbook.

Materials for Duct Air Sealing

Duct mastic is the preferred duct-sealing material because of its superior durability and adhesion. Apply mastic at least $\frac{1}{16}$ -inch thick and use reinforcing mesh or UL 181-approved tape for all joints wider than $\frac{1}{8}$ inch or joints that may experience some movement. Silicone or siliconized acrylic-latex caulk is acceptable for sealing wood-to-wood joints in panned joist spaces that function as return ducts.

Joints should rely on mechanical fasteners to prevent joint movement or separation. Tape alone will not hold a joint together, and it will not resist the force of compacted insulation or joint movement. Aluminum foil tape or cloth duct tape are not good materials for duct sealing because their adhesive often fails after a short time.

3.4.3 Duct Insulation

Insulate forced-air ducts that run through unconditioned areas with foil-faced duct insulation with a minimum value of R-8. Ductwork exposed to the exterior of the building shall be insulated to a minimum value of R-12. Ducts may be insulated with two-part foam products that meet the federal specification for duct insulation. If two-part foam is used, workers must ensure all duct seams are sealed to ensure the air stream does not come in contact with the foam. Aligning with SWS 5.0106.2 and 5.0107.2, the SPF must have a flame spread and smoke index of 25/450 or less tested in accordance with ASTM E84 or UL 723.

Do not apply duct insulation to ducts that will be surrounded by R-8 or more of loose-fill insulation. Before installing the loose-fill insulation, make sure to seal these ducts.

Do not insulate ducts that run through conditioned areas unless they cause overheating in winter or condensation in summer.

Follow these steps when installing duct insulation:

1. Perform necessary duct sealing before insulating ducts.
2. Insulate all exposed forced-air ducts in unconditioned areas so no significant areas of bare duct are left uninsulated.
3. Fasten insulation mechanically, using stick pins, twine, plastic straps, or other appropriate materials. Tape the joints in the insulation to prevent air convection and apply mastic over the tape to increase the tape's longevity.

3.4.4 Measuring System Air Flow

Furnace air flow significantly affects the temperature rise. Excessive air flow (low supply air temperature) may cause customer-comfort issues. Low air flow is a more common problem in forced-air duct systems.

Insufficient air flow may cause short cycling or, in severe cases, failure of the heat exchanger. The most common causes of low air flow are an oversized furnace, a dirty filter, a dirty A-coil, registers or grilles that are blocked, fuel input set too high, fan speed set too low/too high, supply ducts that are too small or are restricted, and inadequate or restricted return ducts. *Table 3-1* shows recommended minimum air flow for various forced-air systems. When air flow is lower than the recommended minimum, the system is likely to have a temperature rise that is higher than the maximum specified by the manufacturer.

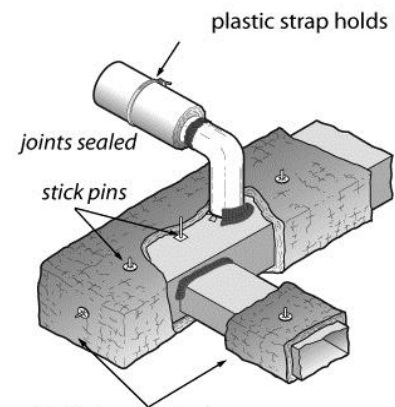

R-8 duct insulation fastened with stick pins.

Table 3-1: Recommended Minimum Air flow (in CFM)

Furnace Size in kBTU	Natural Draft	Fan-Assisted Combustion	Sealed Combustion
40	400	520	600
50	500	650	750
60	600	780	900
75	750	975	1,125
100	1,000	1,300	1,500
	Multiplier		
kBTU	10	13	15
To calculate the estimated minimum air flow for a furnace, multiply the input kBTU by the multiplier for the type of furnace. (e.g., 40 x 15 = 600 CFM).			

Preparing to Measure Air Flow

Sophisticated test instruments are not necessary to discover that filters, air conditioning coils (A-coils), or blowers are packed with dirt or the branch duct to the master bedroom is disconnected. Diagnose these problems before measuring duct air flow. The following steps precede air flow measurements:

1. Ask the customer about comfort problems and temperature differences in various parts of the home.
2. Based on the customer's comments, look for disconnected or restricted ducts.
3. Inspect the filter(s), blower fan, and A-coil for dirt. Clean them if necessary. If the A-coil is not easily visible, a dirty blower fan is a fair indicator that the A-coil may also be dirty.

Flow-Plate Method for Measuring System Air Flow

The flow-plate meter is a plate with holes and sampling tubes that work in conjunction with a digital gauge to measure the velocity and static pressures inside the ductwork. The digital gauge then converts these values into an estimate of the distribution air flow.

The flow-plate meter will contain metering plates that can be configured to fit inside all standard-size filter slots. Whenever possible, make sure the plate is not bigger than the return cutout in the furnace. See the instruction manual for the flow-plate meter for specific directions on its use.

Measuring External Static Pressure

Perform this test if initial temperature rise and CO test results are outside of manufacturer’s specifications and additional investigation is needed. External static pressure (ESP) is the difference between pressures in the supply and return ductwork. ESP is the air flow resistance caused by items external to the furnace cabinet. The ESP test can be used to identify existing ductwork issues such as insufficiently sized ductwork or obstructed cold air returns. Testing for ESP also allows for estimation of air flow if the furnace manufacturer’s fan tables for static pressure and air flow are available.

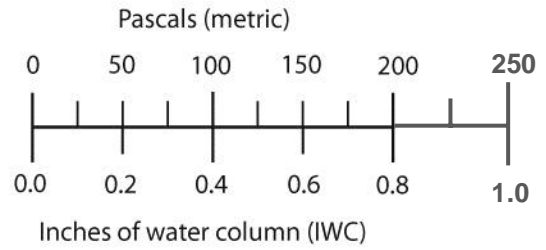

Pressure in two measurement systems:
Technicians and engineers use both pascals (metric) and inches of water column to measure duct pressures.

ESP equals the sum of the absolute values of the static pressures in the supply and return sides. For example, a supply-side static pressure of +30 pascals and a return-side static pressure of -80 pascals indicate an ESP of 110 pascals ($80 + 30 = 110$). The supply-side static pressure will always be a positive number, and the return-side static pressure will always be a negative number. The larger the ESP, the lower the air flow at a given fan speed.

The ESP test requires a static-pressure probe, a pressure hose, and a digital gauge. Follow these steps to test the ESP of a forced-air heating system:

1. Install a clean furnace filter into the filter slot. If one is not available, remove the existing furnace filter if it is plugged or excessively dirty.
2. Drill one hole in the supply plenum, above the furnace cabinet and below the A-coil drain pan (if present). The hole must be large enough to accommodate a static-pressure probe. If the A-coil is mounted directly to the furnace, in order not to drill a hole in the coil or drain pan, drill a hole in the very top of the furnace cabinet. Be sure not to drill through a furnace baffle or heat exchanger. Ensure the hole goes through the insulation inside the furnace cabinet.
3. Drill one hole into the back of the blower cabinet. The hole must be large enough to accommodate a static-pressure probe. Be sure not to drill into wiring or other objects by removing the blower cabinet door to

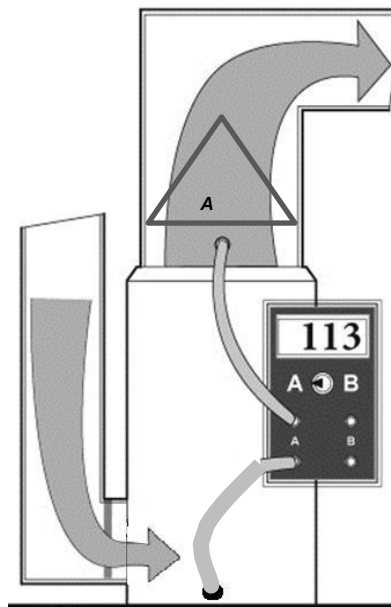

External static pressure (ESP): The positive and negative pressures created by the resistance of the supply and return ducts produces ESP. The measurement shown here simply adds the two static pressures without regard for their signs. As ESP increases, air flow decreases. Numbers shown here are for example only.

External Static Pressure						
ESP (IWC)	0.3	0.4	0.5	0.6	0.7	0.8
CFM	995	945	895	840	760	670

visually select a location free from obstacles. Ensure the hole goes through the insulation inside the blower cabinet.

4. Set the digital gauge to “PR/PR” mode and attach a pressure hose to the Channel A input tap. (The “UNITS” button can be used on the gauge to measure inches of water column).
5. Attach the static-pressure probe to the hose. Insert the probe into each of the holes and record the test result for each hole.
6. Add the absolute values of the two test results, treating each result as if it were a positive number. This sum is the ESP for the heating system.
7. The higher the ESP measurement, the lower the air flow will be (assuming no change in the air handler’s speed setting). The manufacturers’ maximum recommended ESP is usually 0.50 IWC for standard air handlers. As ESP increases above 0.50 IWC, the likelihood of insufficient air flow increases. A very high ESP (over 1.0 IWC) may indicate an oversized furnace, the presence of constricted or insufficient ductwork, a plugged A-coil or furnace filter, or other distribution system issues.

Use the ESP test as a guide, along with customer conversations and the air flow and temperature-rise tests, in determining whether the heating system has sufficient air flow.

3.4.5 Measuring Temperature Rise

Temperature rise is the temperature difference between the supplied air and the return air. This test is critical in determining if the furnace is set up and operating properly. Perform the test after the furnace has reached steady-state and the ductwork has heated up.

Measure the return temperature by inserting the thermometer in the return drop prior to the filter. Measure the supply temperature in a main duct within 6 feet of the supply plenum without being in the line of sight of the heat exchanger. When there are multiple main ducts, measure the temperature in each branch and use the highest reading.

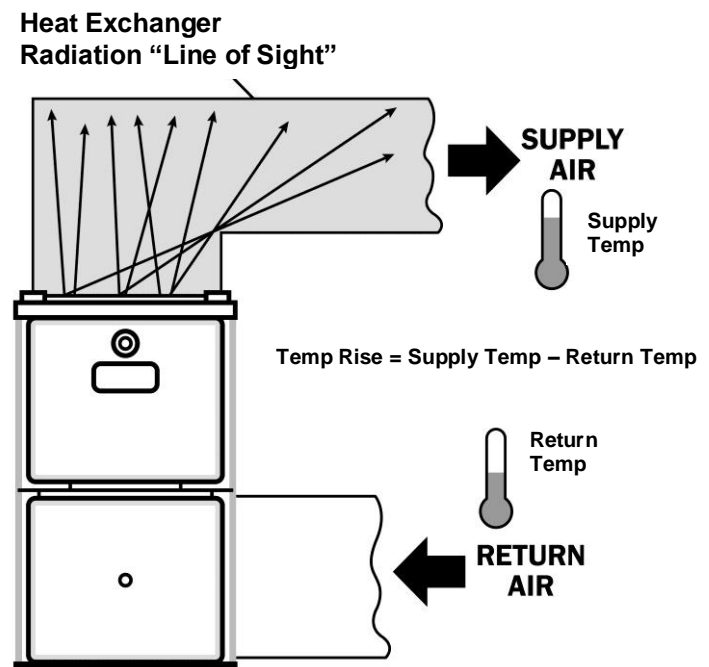

3.4.6 Filters

Observe the following standards related to furnace filter installation.

1. Supply the customer with MERV 6 or higher furnace filters. Provide either:
 - a. Six 1- to 2-inch disposable filters (install one of them in the furnace); or

- b. One washable filter (installed); or
 - c. One deep-pleated filter (installed).
- 2. Confirm filters are held firmly in place and provide complete coverage of the blower intake or the return register.
- 3. Ensure filters are easy to replace.
- 4. Confirm the heating system has a sealing filter cover and install a new one if none exists. Construct the new filter slot cover so it can be removed easily and safely. Confirm the filter is easy to access and replace. Magnetic filter covers are allowed only if they provide an adequate seal to the ductwork to prevent air leakage.

3.5 Boiler Replacement

Complete all tests on the Hot Water Boiler Replacement Check List and document results. Follow these specifications when replacing boilers:

1. To size a replacement system accurately, use an accurate analysis through REScheck, ACCA Manual J, or an equivalent industry-accepted sizing procedure by calculating the heating loads based on the post-retrofit dwelling characteristics. Consider the home's design temperature heat loss, the room-by-room heat loss, and the home's existing radiation capacity. In situations of insufficient radiation capacity, the home may need more heat emitters to optimize the new system's efficiency and to heat all rooms adequately.
2. Flush the existing distribution system per manufacturer's instructions or until the water runs clean and is free of sediment. Verify proper pH and sediment values as provided by manufacturer. With a zoned system, flush each zone separately.
3. Install isolation valves at accessible points in the supply- and return-pipe connections and as near to the boiler as is convenient and practical to permit draining the boiler without emptying the system. These valves can also serve for filling the system and purging air from separate zones.
4. Locate new zone valves or zone circulating pumps near the boiler. Confirm each zone has its own shut-off valve.
5. Install a pressure relief valve (PRV) per manufacturer's instructions. Confirm the PRV is rated and sized correctly for the boiler BTU input and maximum operating pressure.
6. Install an automatic fill valve, if none is present.
7. The feed-water (inlet) side of the pressure-reducing feed valve shall have a backflow preventer, with a shut-off valve installed upstream from the backflow preventer, and the boiler (outlet) side of the pressure-reducing feed valve also shall have a shut-off valve to allow for maintenance or replacement without draining the boiler system.
8. The backflow preventer drain shall face the floor.
9. The system shall have an adequately sized expansion tank on the supply side of the boiler. Install an expansion tank or fill the existing expansion tank and the system to the correct level.
10. Install the circulator pump near the downstream side of the expansion tank to prevent the suction side of the pump from depressurizing the piping.
11. Verify return-water temperature is appropriate:
 - a. For oil boilers, verify return-water temperature is above 150°F.
 - b. For non-condensing gas boilers, verify return-water temperature is above 130°F to prevent acidic condensation within the boiler.



12. Install piping bypasses, mixing valves, primary-secondary piping, or other strategies as necessary to prevent condensation.
13. For condensing boilers, install condensation-resistant venting with condensation drains designed into the venting system per the manufacturer's specifications.
14. Insulate all pipes on the circulating loop between the boiler and an indirect domestic water heater.
15. When installed on a floor below grade, a new boiler shall be installed above known flood levels and as high as practical to avoid damage in case of flooding.
16. Inspect the chimney for deterioration and correct sizing. Repair and reline the chimney as necessary.
17. With standard-efficiency boilers, install a full-closure electric vent damper where feasible.

3.5.1 High-Efficiency ($\geq 90\%$ +) Boilers

High-efficiency boilers often present significant energy-saving opportunities as compared with standard-efficiency boilers. Similar to $\geq 90\%$ efficient furnaces, high-efficiency boilers cause water vapor in the exhaust gases to condense, which releases extra heat and raises its efficiency potential above 90 percent. (High-efficiency systems are often referred to as “condensing” systems.)

To size a replacement system accurately, consider the home's design temperature heat loss, the room-by-room heat loss, and the home's existing radiation capacity. In situations of insufficient radiation capacity, the home may need more heat emitters to optimize the new system's efficiency and to heat all rooms adequately.

With a high-efficiency boiler, the return water acts as a coolant for the exhaust gases. The lower the temperature of the return water, the more the exhaust gases cool — which in turn increases the amount of water that condenses out of the exhaust, and thus increases the boiler's efficiency. For this reason, lower return-water temperatures correlate with increased efficiencies.

Outside air temperature sensors are installed with a boiler to allow the boiler controls to sense the actual outside temperature. Outdoor reset is a control function allowing the boiler to adjust the supply-water temperature to the minimum needed to heat the building at a given outside temperature. When the boiler limits its heat output to the dwelling's actual need, the lower return-water temperature increases condensation and increases the boiler's efficiency.

High-efficiency boilers require regular maintenance. Some high-



efficiency boilers are especially vulnerable to problems with the distribution water — namely, dirt/debris/sediment/rust in the water and/or an improper pH level, both of which can lead to plugged heat exchangers and other issues. Educate customers and make sure they understand the maintenance requirements.

Follow these additional instructions when installing high-efficiency boilers:

1. Verify flue-gas O₂ percent or CO₂ and CO ppm are within the manufacturer's ranges for both high and low fire.
2. Equip the boiler with an outside air temperature sensor installed on a north-facing exterior wall. Determine the outdoor temperature above which the boiler should not operate and set high temperature shutoff to match.
3. Program the modulating boiler's heating curve in line with the dwelling's heat loss, outdoor design temperatures and radiation capacity.
4. Ensure the chemistry of the distribution water meets manufacturer's specifications. Testing may include pH, hardness/total dissolved solids (TDS), or inhibitor treatment.
5. Flush water distribution system using manufacturer recommended treatment chemicals designed to remove rust and debris from inside the system.

3.6 Hydronic Distribution Systems

Hydronic distribution systems consist of the supply and return piping, the circulator, expansion tank, air separator, air vents, and heat emitters. A properly designed and installed hydronic distribution system can operate for decades. Many systems, however, have installation flaws or need service.

Boiler piping and controls present many options for zoning, boiler staging, and energy-saving controls. Dividing homes into zones, with separate thermostats, can significantly improve energy efficiency over operating a single zone. Modern hydronic controls can provide hot water for heating to different zones at different times with varying heating loads in the zones.

Follow these instructions for hydronic distribution systems:

1. Inspect radiators. Repair or replace as necessary.
2. Bleed air from radiators and from the entire system.
3. Confirm the distribution system has no leaks.
4. Modify the distribution system as necessary to work properly with the replacement boiler.
5. Install additional emitters (radiators or baseboard) as needed to allow for lower water temperatures to ensure new boilers will achieve rated AFUE (condensing of flue gases).

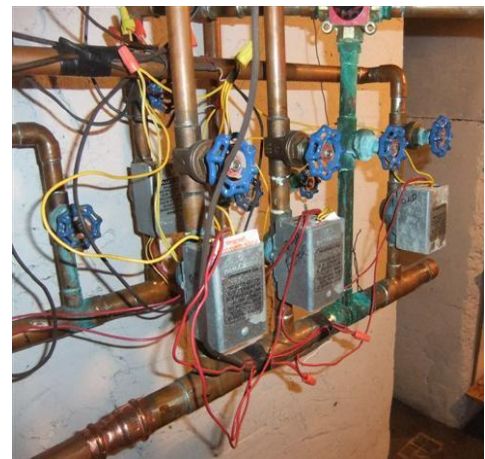

Zone valves: A separate thermostat controls each zone valve. When a thermostat calls for heat, the boiler fires and the zone valve opens.

6. The system shall have automatic and manual air-bleed valves to eliminate air from all high points in the distribution-piping system.
7. Extend new piping and radiators to conditioned areas, like additions and finished basements currently heated by space heaters.
8. Install thermostatically controlled radiator valves on the major radiators or zone controls or outdoor reset and boiler controls to adjust supply-water temperature according to outdoor temperature. If feasible for the boiler system. Modulating pumps on multi-zoned systems may be considered.
9. Insulate all supply piping outside conditioned spaces. For hot-water systems, install 1½-inch fiberglass insulation on all pipes less than or equal to 1½ inches in diameter, and 2-inch fiberglass insulation on all pipes greater than 1½ inches in diameter. For steam systems, install 1½-inch fiberglass insulation on all pipes less than or equal to 1½ inches in diameter, and 3-inch fiberglass insulation on all pipes greater than 1½ inches in diameter.

3.7 Boiler Efficiency and Maintenance

Boilers can maintain good performance and efficiency for many years if they are regularly maintained and tuned up. Boiler performance and efficiency improve after effective maintenance and tune-up procedures.

Modern high-efficiency boilers require annual maintenance to achieve optimum performance and life expectancy. For information about boiler installation, see *Boiler Replacement in Chapter 3 – Section 3.5*.

Boiler performance and efficiency deteriorate in more ways than in forced-air furnaces. Specifically, these are:

1. Corrosion, scaling, and dirt on the water side of the heat exchanger.
2. Corrosion, dust, and dirt on the fire side of the heat exchanger.
3. Excess air during combustion from air leaks and incorrect fuel-air mixture.
4. Off-cycle air circulation through the firebox and heat exchanger, removing heat from stored water.

Consider the following maintenance and efficiency improvements for both hot water and steam boilers:

1. Check for leaks on the boiler, around its fittings, or on any of the distribution piping connected to the boiler.
2. Install a magnetic filter on return piping just before boiler to prevent scaling on heat exchanger.
3. Install or replace old circulating pumps with electrically efficient ECM models.
4. On a steam boiler, inspect the water gauge glass for erosion, cracks, or drying. Replace

damaged gauge glass on the boiler in accordance with manufacturer specifications. Remove, clean, and replace the gauge glass when dirt or sediment is coating it and making it difficult to observe the water level of the boiler.

5. Clean noticeable dirt from the fireside of the heat exchanger.
6. Check doors and cleanout covers for air leakage. Replace gaskets, warped doors, or warped cleanout covers.
7. Drain water from the boiler drain until the water flows clean.

Safety Checks and Improvements

1. Confirm the existence of a 30 psi-rated pressure relief valve. Replace a malfunctioning valve or add one if none exists. Note signs of leakage or discharges and find out why the relief valve is discharging.
2. Make sure the expansion tank is not waterlogged or sized too small for the system. This could cause the pressure relief valve to discharge. Test expansion tank for acceptable air pressure — usually 12 to 22 psi.

Note: A hot-water boiler is recognized by its expansion tank, located somewhere above the boiler. The expansion tank provides an air cushion to allow the system's water to expand and contract as it is heated and cooled without creating excessive pressure in the boiler piping and discharging through the pressure relief valve.

3. If rust is observed in the venting, verify return water temperature is above 130°F for gas and above 150°F for oil, to prevent acidic condensation.
4. Verify the system does not cycle on high limit.
5. Lubricate circulator pump(s) if necessary.

Efficiency Improvements

1. Repair water leaks in the system.
2. Remove corrosion, dust, and dirt on the fireside of the heat exchanger.
3. Check for excess air during combustion from air leaks and incorrect fuel-air mixture.
4. Confirm the boiler does not have low-limit control for maintaining a minimum boiler-water temperature unless the boiler is heating domestic water in addition to space heating.
5. Consider installing outdoor reset controllers on non-high-efficiency boilers to regulate water temperature, depending on outdoor temperature.

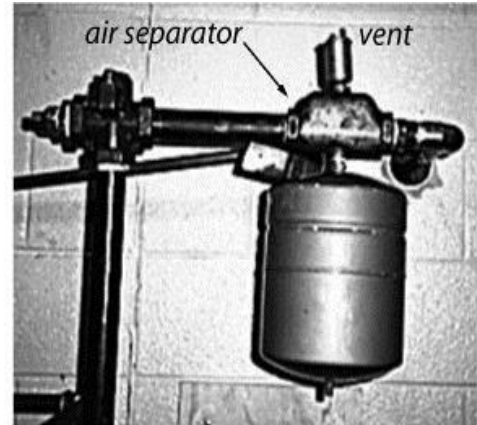

Expansion tank, air separator, and vent: Preventing excessive pressure and eliminating air from the systems are important for hydronic distribution systems.

6. After control improvements like two-stage thermostats or reset controllers, verify return-water temperature is high enough to prevent condensation and corrosion in the chimney is noted previously.
7. Bleed air from radiators and piping through air vents on piping or radiators.
8. Vacuum and clean fins of fin-tube convectors if dust and dirt is present.
9. Consider installing full-closure electric vent dampers on natural-draft gas- and oil-fired high-mass boilers.

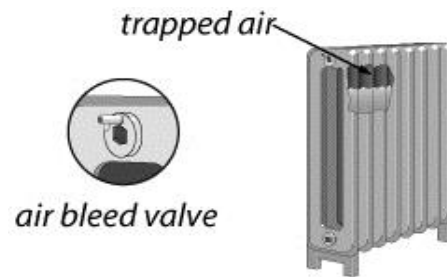

Purging air: Trapped air collects at the hot-water system's highest parts. Bleeding air from radiators fills the radiator and gives it more heating surface area.

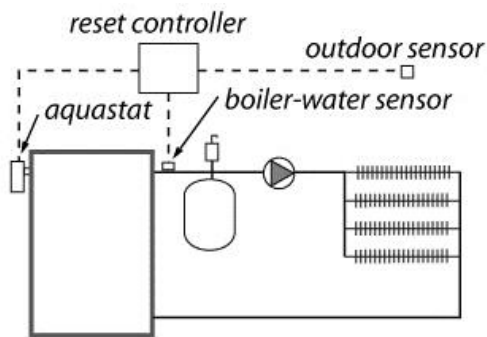

Reset controller: The circulating water temperature is controlled by the reset controller according to the outdoor temperature.

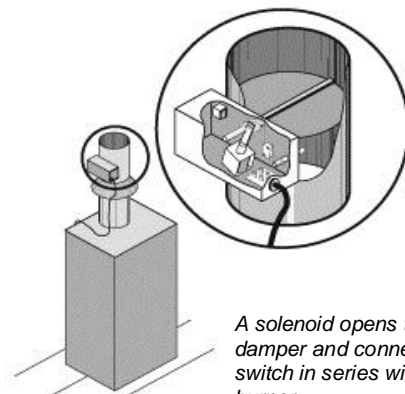

A solenoid opens the damper and connects a switch in series with the burner.

Vent dampers: Electric vent dampers close the chimney when the burner is not firing, preventing circulating air from carrying the boiler's stored heat up the chimney.

3.8 Gas-Fired Heating Systems

3.8.1 Gas-Fired Heating System Installation

The general procedures outlined in *General Heating-System Replacement in Chapter 3 – Section 3.2*, should be followed. Complete all tests on the Replacement Gas Furnace Check List and document results.

When replacing a gas-fired heating system:

1. Confirm the clearances to nearby combustibles of the heating unit and its vent connector conform to NFPA 54.
2. Clock the gas meter, if necessary, to troubleshoot oxygen, flue-gas temperature, carbon monoxide, or temperature-rise problems, and to verify the actual gas input matches with the nameplate input rating. Adjust gas input if necessary. See *Measuring BTU Input on*

Natural Gas Appliances in Chapter 3 – Section 3.8.3.

3. Check the input gas pressure on the furnace when all gas-fired appliances are operating in the house to ensure no drop-off in required gas pressure. If the input is significantly different than the rating on the nameplate, all other variables above can be affected.
4. Measure manifold gas pressure to ensure it stays within the manufacturer's specified range. Adjust the fuel-air mixture for the lowest CO output and maximum SSE.
5. Follow manufacturer's venting instructions, along with the NFPA 54 to establish a proper venting system.
6. Follow manufacturer's instructions for proper removal of condensate. See *Condensate Removal in Chapter 3 – Section 3.8.2.*
7. Install a proper sediment trap on the gas line, if none exists.
8. When fuel switching from oil to gas, place the old oil tank out of service in accordance with Wisconsin Administrative Code ATCP 93.315.

3.8.2 Condensate Removal

Condensate is routed away from the furnace in one of two ways:

1. Running condensate tubing or piping directly from the furnace to an appropriate drain (Preferred Method); or
2. Pumping the condensate from the furnace to an appropriate drain using an electric condensate pump.

Whenever feasible, pipe directly from the furnace to the floor drain, without installing a condensate pump. Mechanically fasten the piping, either to the floor-drain strainer or to the floor itself. Ensure the piping will not pose a tripping hazard to the occupants. Installing a "trip strip," with the customer's approval, may be useful to prevent occupants from tripping over the piping.

Sometimes, a direct-piping strategy will not be feasible. There may not be a drain near the furnace, or perhaps the piping would pose a tripping hazard to the occupants. In these situations, installing a condensate pump is likely a better option. See the next section for information about condensate pumps.

Condensate Pumps

A condensate pump is installed when direct piping to an approved drain is not feasible. Condensate pumps may be installed using existing receptacles, new ground-fault circuit interrupter (GFCI) receptacles, or directly wired in accordance with pump manufacturer's requirements. Inspect the entire condensate system for leaks after installation. Insulate the condensate drain system when it is located in an unconditioned area or has the potential to form condensation. If a condensate pump is installed in or above a finished area, a secondary drain pan should be installed with a safety feature to disable the heating system if the pump fails.

Condensate is a slightly acidic byproduct of combustion. Plumbing code requires it to be drained

to the sanitary sewer system, and not to the ground or to a sump pump. Code allows condensate to go to a floor drain, a standpipe, or an indirect or local wastepipe served by a standpipe or the laundry tray tail piece. An air gap is required where the condensate line enters the receptor. The condensate line cannot go directly into any drainpipe. See SPS 382.33 for Wisconsin code provisions regarding condensate drains.

Floor drain: The floor drain is the most common method for discharging condensate. Condensate lines that run to the drain must be secured to the floor to keep them in place. This method works best when the drain is not in a typical path of foot traffic.



Standpipe: The laundry standpipe is often the best place to discharge condensate. If the opening is not large enough for the washing machine hose and the condensate line, an adapter can be added to enlarge the top of the pipe. A standpipe cannot exceed 36 inches in height above the centerline of the horizontal drainpipe. If an existing standpipe is not an

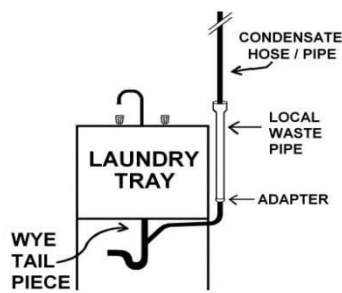

option, a new standpipe, trapped and vented, is acceptable. This option should be the last choice, as the trap can dry out if the heating system does not discharge condensate over an extended time. If a washing machine could be discharged into the standpipe, extend the standpipe at least 18 inches above the centerline of the horizontal drainpipe.

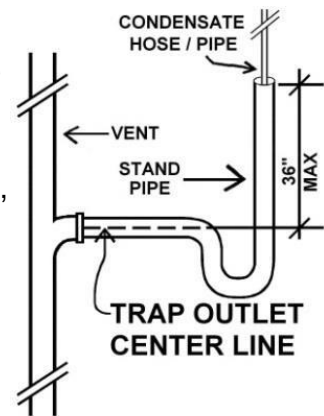

Indirect or local wastepipe: A vertical pipe that uses the trap of a standpipe or laundry tailpiece is considered an indirect or local wastepipe. It needs to be higher than the flood line of the laundry tray or standpipe. This method can also be used if the existing standpipe is full of other hoses.

3.8.3 Testing and Servicing Gas-Fired Systems

Gas burners should be cleaned and tuned every two to four years. Sometimes a maintenance schedule will be posted on an existing heating system, allowing assessment of the heating-system maintenance history (or lack thereof).

The goals of these service measures are to reduce CO, to optimize fuel-air mixture, and to

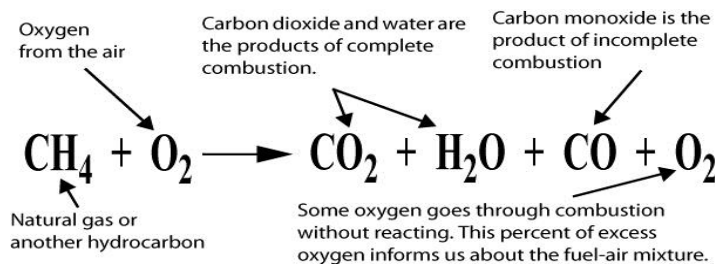

confirm the operation of safety controls. Complete all tests on the Heating System Repair or Clean and Tune Check List and document results.

Perform the following inspection and maintenance procedures, as necessary, on gas-fired furnaces, boilers, water heaters, and space heaters:

1. Inspect for soot, melted wire insulation, melted grommets, and rust in the burner and manifold area outside the firebox. These all are indicators of flame rollout, combustion-gas spillage, and CO production.
2. Inspect the burners for dust, debris, misalignment, flame impingement, and other flame-interference problems. Clean, vacuum, and adjust as needed.
3. Inspect the heat exchanger for leaks.
4. Verify heating system wiring connections are enclosed in covered electrical boxes.
5. Determine the pilot is burning (if equipped) and main burner ignition is satisfactory.
6. Sample the undiluted combustion gases with a calibrated flue-gas analyzer and record steady-state efficiency, O₂ percentage, CO ppm (as-measured), and flue-gas temperature.

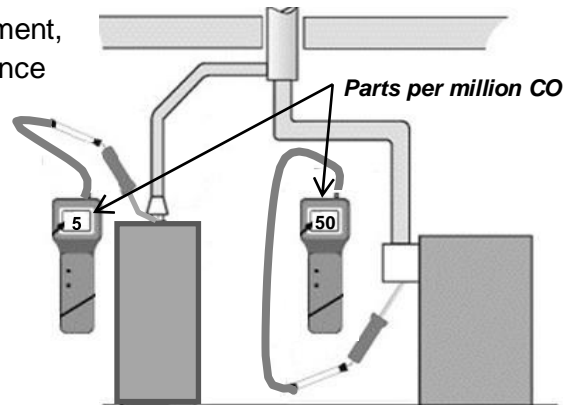

Sampling combustion gases: Sample combustion gases at the exhaust vent of the appliance before dilution air mixes with the gases.



Testing older furnaces: Insert the probe into the draft diverter near the exhaust ports of the heat exchanger.



Testing 80+ furnaces: Drill a quarter-inch hole in the metal vent connector to sample combustion gases.

7. Clock the natural-gas meter, with all other gas appliances off, to confirm the input BTUs to the furnace or boiler match with the nameplate rating. Adjust gas pressure if necessary. See *Measuring BTU Input on Natural Gas Appliances in Chapter 3 – Section 3.8.3* for clocking the meter.
8. Clean the air handler (“squirrel cage”) and the air- handler cabinet. Adjust the air handler’s speed setting, if necessary, to ensure adequate air flow and to ensure temperature rise is within the manufacturer’s specifications.
9. Test pilot safety control for complete gas valve shut-off when pilot is extinguished.
10. When testing is complete, seal all test holes.
11. Verify the thermostat’s heat-anticipator setting matches the measured current in the 24-volt control circuit.
12. Check venting system for proper size and pitch.
13. Check venting system for obstructions, blockages, or leaks.
14. Measure chimney draft downstream of the draft diverter and check for spillage.
15. Measure gas input, and observe flame characteristics if soot, CO, or other combustion problems are present.



Adjusting gas pressure: Adjusting gas pressure is the only way to change the fuel-air mixture.

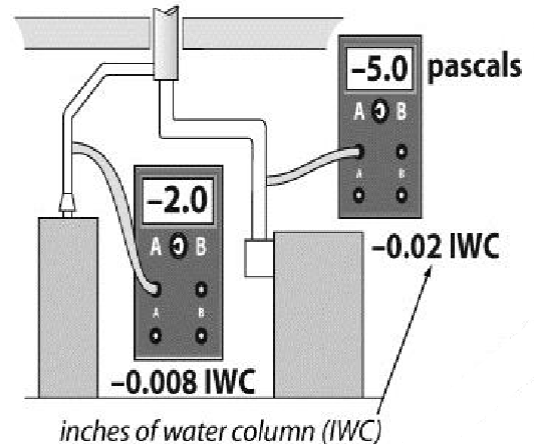

Measuring draft: Measuring chimney draft downstream from the draft diverter.

A common furnace-efficiency problem is low fuel input and high O₂ percentage, resulting in poor heat transfer. This condition will be detected by combustion testing and clocking the natural-gas meter. See the standards for O₂ percentage and flue-gas temperature in *Table 3-2*.

Flue-gas temperature is another important indicator of furnace performance. A low flue-gas temperature usually indicates efficient performance, since less of the heat is leaving the building. If the flue-gas temperature is too low in older furnaces or 80+ furnaces, acidic condensation will form in the vent. This acidic condensation can rust metal vents and damage masonry chimneys.

Adjust gas pressure and air flow in order to optimize gas input, O₂ percentage, flue-gas temperature, and SSE. These adjustments are best made while monitoring the exhaust gas with the combustion analyzer.

Table 3-2: Typical Ranges for Gas Burning Appliances

Performance Indicator	SSE 80+	SSE 90+
Carbon monoxide (CO) (ppm) air-free	≤ 400	≤ 400
Stack temperature (°F)	325° – 450°	90° – 120°
Temperature rise (°F)	40° – 70°	30° – 70°
Oxygen (O ₂)	4 – 9%	4 – 9%
Gas pressure output at manifold - inches of water column (IWC)	3.2 – 3.9	3.2 – 3.9
Propane pressure output at manifold (IWC)	10 – 11	10 – 11
Steady-state efficiency (SSE)	82 – 86%	92 – 97%
Supply temperature (°F)	120° – 140°	95° – 140°

Proceed with burner maintenance and adjustment when any of the following are present:

1. When CO level exceeds the designated threshold for the specific gas burning appliance
2. Visual indicators of soot or flame rollout exist
3. Burners are visibly dirty

See *CO Corrective Actions in Chapter 5 – Table 5-2*.

Troubleshooting CO

CO Exceeds Limit in One Chamber

1. Open the primary air shutter of the burner where CO is above acceptable limits.
2. Clean that burner and/or pilot assemblies.
3. Align the burner and/or pilot assembly to eliminate impingement.
4. Check orifice size and alignment.
5. Check for flame movement and cracks in the heat exchanger.

CO Exceeds Limit in Two Chambers

1. Confirm combustion air source.
2. Check venting system and heat exchanger for blockages.
3. Open primary air shutter on each burner.
4. Clean burners and/or pilot assembly
5. Check orifice size and gas pressure.
6. Measure the appliance input and adjust if necessary.

Carbon Build-up in Heat Exchanger

1. Clean out carbon build-up.
2. Clean all other combustion surfaces including burners, pilot assembly, orifice, and baffles.
3. Inspect heat exchanger for cracks.
4. Reassemble the furnace:
 - a. Set primary air openings.
 - b. Check gas pressure and orifice size.
 - c. Align, position, and level burners.
5. Check venting system and heat exchanger for blockages.
6. Measure the appliance input and adjust if necessary.

Procedures Fail to Reduce CO Below Limit

Re-check the Following Upon:

1. Primary air adjustment.
2. Burner level, alignment, and position.
3. Combustion air source.
4. Gas pressure is correct for type of fuel.
5. Appliance input is altitude adjusted.
6. Venting system is free of obstructions.
7. Heat exchanger is intact.
8. No flame impingement present

Table 3-3: Combustion Problems and Possible Solutions

Problem	Possible Causes and Solutions
Weak draft with CAZ depressurization	Return duct leaks, clothes dryer, exhaust fans, other chimneys. Seal return leaks. Provide make-up air.
Weak draft with no CAZ depressurization	Chimney blocked or leaky or else CAZ is too airtight.
Carbon monoxide	Mixture too rich or too lean. Adjust gas pressure. Check chimney and combustion air for code compliance.
Stack temperature or temperature rise too high or low	Adjust fan speed or gas pressure. Improve ducts to increase air flow.
Oxygen too high or low	Adjust gas pressure, but do not increase CO level.

Gas burner maintenance includes the following measures:

1. Remedy the causes of CO and soot. These causes may include overfiring, closed primary air intake, flame impingement, and lack of combustion air.
2. Remove dirt, rust, and other debris that may be interfering with the burners. Clean the heat exchanger, if necessary.
3. Take action to improve draft if inadequate because of improper venting, obstructed chimney, leaky chimney, or depressurization. See *Improving Inadequate Draft in Chapter 3 – Section 3.14.1*.
4. Seal leaks in vent connectors and chimneys.
5. Adjust gas input if combustion testing or clocking the gas meter indicates overfiring or under-firing.

Measuring BTU Input on Natural Gas Appliances

1. Turn off gas supply to all gas-combustion appliances not being tested (such as heating systems, water heaters, dryers, cook stoves, space heaters, etc.) that are connected to the meter being timed.
2. Fire the appliance being tested and watch the dials of the gas meter.
3. Carefully count how long it takes for one revolution of the ½-, 1-, or 2-cubic-foot dial. Find that number of seconds in the columns marked “Seconds per Revolution” in *Table 3-4*. Follow that row across to the right to the correct column for the ½-, 1-, or 2-cubic foot dial. Multiply the number in the table by 1,000. Record the input in thousands of BTUs per hour. *For gauging a ¼-cubic-foot dial,*

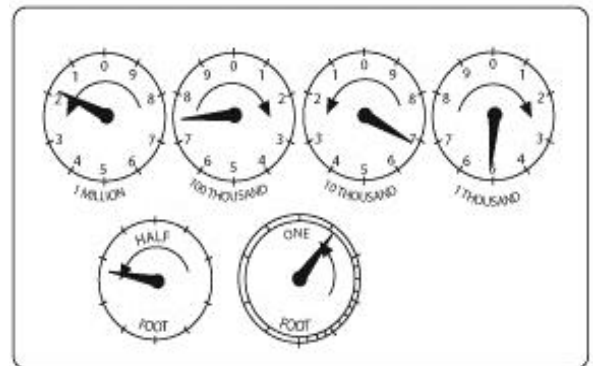

Gas meter dial: Use the number of seconds per revolution of the one-foot dial and the table on the following page to find the appliance’s input.

count how long it takes for 4 revolutions. Then, use the 1-cubic-foot column to determine the input.

4. If the measured input is higher or lower than input on the nameplate by more than 10 percent, adjust gas pressure up or down, within the ranges in *Table 3-3*, until the approximately correct input is achieved. **CAUTION:** Consult with fuel supplier before adjusting pressure at meter.
5. For LP gas, determine the orifice size. From Table E.1.1 of the National Fuel Gas Code, find the input BTU value that corresponds with the orifice size. Multiply the listed BTU value by the number of orifices to get the input BTU for the heating system.
6. If the measured input is still out of range after adjusting gas pressure to these limits, replace the existing orifices with larger or smaller orifices sized to give the correct input. Any changes done to orifices must follow manufacturer's instructions.

Table 3-4: Input in Thousands of BTU/hr for 1000 BTU/cu. ft. Gas

Seconds per Revolution	Size of Meter Dial			Seconds per Revolution	Size of Meter Dial			Seconds per Revolution	Size of Meter Dial		
	½ cu. ft.	1 cu. ft.	2 cu. ft.		½ cu. ft.	1 cu. ft.	2 cu. ft.		½ cu. ft.	1 cu. ft.	2 cu. ft.
15	120	240	480	40	45	90	180	70	26	51	103
16	112	225	450	41	44	88	176	72	25	50	100
17	106	212	424	42	43	86	172	74	24	48	97
18	100	200	400	43	42	84	167	76	24	47	95
19	95	189	379	44	41	82	164	78	23	46	92
20	90	180	360	45	40	80	160	80	22	45	90
21	86	171	343	46	39	78	157	82	22	44	88
22	82	164	327	47	38	77	153	84	21	43	86
23	78	157	313	48	37	75	150	86	21	42	84
24	75	150	300	49	37	73	147	88	20	41	82
25	72	144	288	50	36	72	144	90	20	40	80
26	69	138	277	51	35	71	141	94	19	38	76
27	67	133	267	52	35	69	138	98	18	37	74
28	64	129	257	53	34	68	136	100	18	36	72
29	62	124	248	54	33	67	133	104	17	35	69
30	60	120	240	55	33	65	131	108	17	33	67
31	58	116	232	56	32	64	129	112	16	32	64
32	56	113	225	57	32	63	126	116	15	31	62
33	55	109	218	58	31	62	124	120	15	30	60
34	53	106	212	59	30	61	122	130	14	28	55
35	51	103	206	60	30	60	120	140	13	26	51
36	50	100	200	62	29	58	116	150	12	24	48
37	49	97	195	64	29	56	112	160	11	22	45
38	47	95	189	66	29	54	109	170	11	21	42
39	46	92	185	68	28	53	106	180	10	20	40

3.8.4 Leak-Testing Gas Piping

For information on leak-testing gas piping, see *Gas Piping Inspection in Chapter 5 – Section 5.8.1*.

3.9 Oil-Fired Heating Systems

3.9.1 Oil-Fired Heating System Installation

The general procedures outlined in *General Heating System Replacement in Chapter 3 - Section 3.2* should be followed when replacing an oil heating system. Complete all tests on the Oil Replacement Furnace Check List and document results.

When replacing an oil furnace:

1. Properly size the nozzle based on the post-weatherization conditions using REScheck®, Manual J, or an equivalent industry-accepted sizing formula. Document the nozzle size on the inside of the furnace cabinet next to the furnace nameplate.
2. Examine the existing chimney and vent connector for suitability as venting for the new appliance. The vent connector may need to be resized, and the chimney may need to be relined.
3. Confirm the clearances to nearby combustibles of the heating unit and its vent connector conform to NFPA 31.
4. Test oil pressure, and verify it complies with the manufacturer's specifications.
5. Test control circuit amperage and adjust the thermostat's heat anticipator to match.
6. Test smoke number to confirm it meets manufacturer's specifications. See *Table 3-5*. Install a new fuel filter and purge the fuel lines.
7. Verify the chimney operates safely and in accordance with NFPA 211.
8. Confirm the tank and oil lines comply with NFPA 31.

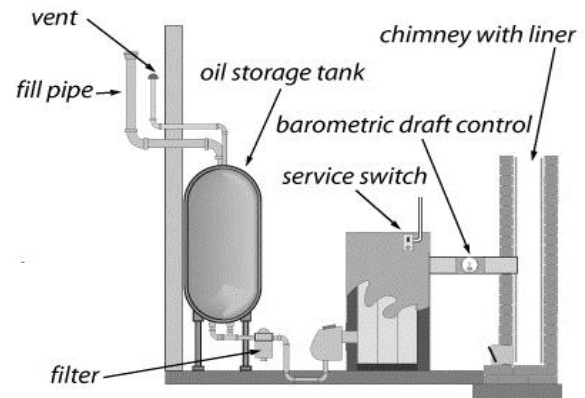

Oil heating system: Components of an oil heating system may need repair and cleaning during replacement of the furnace or boiler.

3.9.2 Testing and Servicing Oil-Fired Systems

Oil burners require annual maintenance to retain their operational safety and combustion efficiency. Use results from steady-state efficiency, draft, carbon monoxide and smoke tests to guide and evaluate maintenance. These clean-and-tune procedures pertain to oil-fired furnaces, boilers, and water heaters.

Oil Burner Inspection and Testing

Evaluate oil burner operation by visually inspecting and combustion testing the system. An oil burner passing visual inspection with good test results may need minimal maintenance. If the test results are fair, adjustments may be necessary. Unsatisfactory test results may indicate the need to replace the burner or the entire heating unit.

Follow these steps to improve oil burner safety and efficiency:

1. Inspect burner and appliance for signs of soot, overheating, fire hazards, corrosion, or wiring problems.
2. Equip all oil-fired heating systems with a barometric draft control.
3. Confirm the oil heating system has a dedicated electrical circuit.
4. Enclose all 120-volt wiring connections in covered electrical boxes.
5. Inspect fuel lines and storage tanks for leaks.
6. Inspect the heat exchanger and combustion chamber for cracks, corrosion, or soot buildup.
7. Check to see if the flame ignition is instantaneous or delayed. The flame ignition should be instantaneous, except for pre-purge units where the blower runs for a while before ignition.
8. Sample undiluted flue gases with a smoke tester, following the smoke tester instructions.

Compare the smoke smudge left by the gases on the filter paper with the manufacturer's smoke-spot scale to determine smoke number. *With a smoke number of two or higher, do not use the electronic combustion analyzer.*

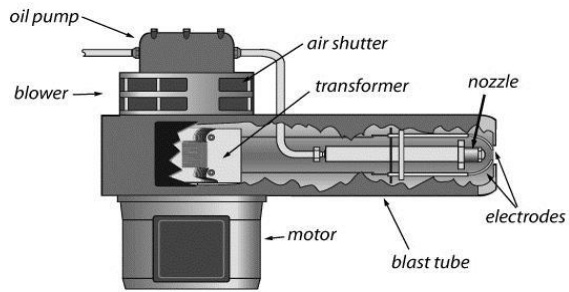

Oil burner operation: For continual and complete burning of the oil, oil is pumped through the nozzle to create a specific spray pattern that is ignited by properly spaced electrodes carrying 10,000 volts from the transformer.

Table 3-5: Typical Ranges for Oil Burning Appliances

Performance Indicator	Non-Flame Retention	Flame Retention
Carbon monoxide (CO) (ppm) in flue gas	400 ppm air-free	400 ppm air-free
Stack temperature (°F)	325° - 550°	300° - 450°
Oxygen (O ₂)	6-9%	5-9%
Smoke number (1-9)	≤ 2	≤ 1
Excess air (%)	≥ 80%	≥ 35%
Oil pressure pounds per square inch (psi)	≥ 100	100 -150
Overfire draft (inches of water column - IWC negative)	.02 IWC or 5 Pa	.02 IWC or 5 Pa
Flue draft (IWC negative)	.04 -.01 IWC or 10-15 Pa	.04 -.01 IWC or 10-15 Pa
Steady-state efficiency (SSE)	≥ 75%	≥ 80%

9. Analyze the flue gas for O₂ percentage, temperature, CO ppm, and steady-state efficiency (SSE). Sample undiluted flue gases between the barometric draft control and the appliance. Adjust fuel-air mixture and air flow to conform to standards in *Table 3-5*.
10. Measure flue draft between the appliance and barometric draft control and overfire draft at an opening to the firebox.
11. Measure high-limit shut-off temperature and adjust or replace the high-limit control if the shut-off temperature is more than 200°F for furnaces or 180°F for hot-water boilers.
12. Measure the oil-pump pressure and adjust to manufacturer's specifications if necessary.
13. Measure transformer voltage and replace transformer if not within the allowable range.
14. Ensure barometric draft controls are mounted plumb and level and the damper swings freely.
15. Time the CAD cell control or stack control to verify the burner will shut off within the time frame per manufacturer's specifications when the CAD cell is blocked from seeing the flame.

Oil Burner Maintenance and Adjustment

After evaluating the oil burner's initial operation, perform the following maintenance tasks as needed to optimize safety and efficiency:

1. Verify correct flame-sensor operation.
2. Replace the burner nozzle after matching the new nozzle's size to the home's post-weatherization heat load requirements.
3. Clean the burner's blower wheel.
4. Replace oil filter(s).
5. Clean or replace air filter. See *Filters in Chapter 3 – Section 3.4.6* for guidance on providing furnace filters.
6. Remove soot and sludge from combustion chamber.
7. Remove soot from heat exchanger surfaces.
8. Clean dust, dirt, and grease from the burner assembly.
9. Ensure the oil pump is set to the correct pressure.
10. Adjust barometric damper for a negative overfire draft of 5 pascals or 0.02 IWC, per manufacturer's specifications.
11. Adjust gap between electrodes and their position in burner tube, per manufacturer's specifications.
12. Repair the ceramic combustion chamber or replace it if necessary.
13. Inspect and clean the end of the burner-tube assembly. Replace flame retention head if damaged.
14. Inspect and clean the transformer contacts to remove any corrosion.

15. Adjust air shutter to achieve O₂ and smoke values, specified in *Table 3-5*.

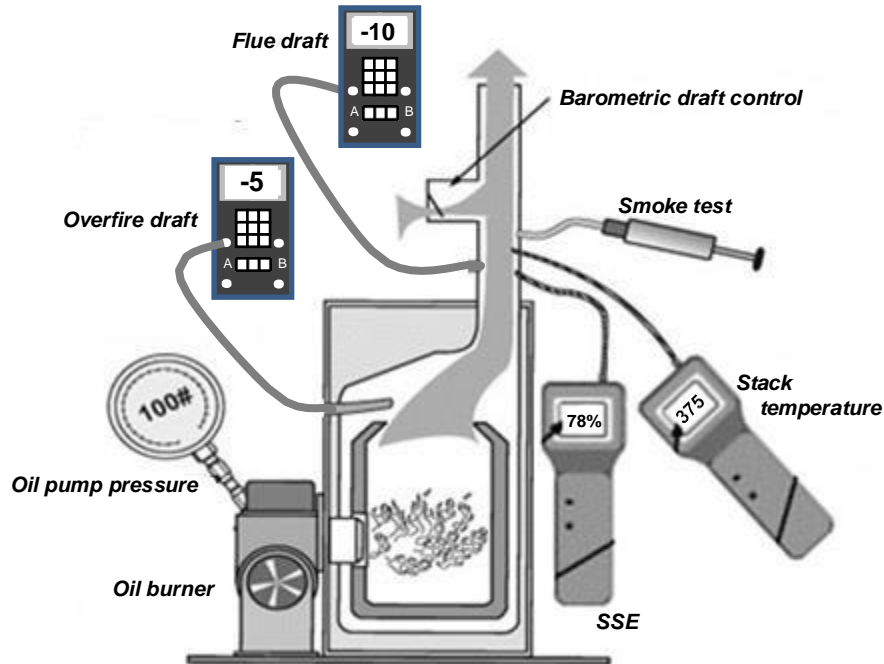

Measuring oil burner performance: To measure oil-burning performance indicators, a manometer, flue-gas analyzer, smoke tester, and pressure gauge are required.

After these maintenance procedures, perform the diagnostic tests described previously to evaluate improvement made by the maintenance procedures and to determine if fine-tuning is required.

3.10 Electric Furnaces and Electric Baseboard Heat

In Wisconsin, electric baseboard heat is much more common than electric furnaces. Due to the high cost of electricity, these systems may be good candidates for fuel switching or converting to a heat pump.

Caution: Disconnect power from electric furnaces before performing any maintenance.

1. Check or clean and lubricate the following components: thermostat, blower, housing around electric element, and baseboard fins.
2. Clean or replace all filters.
3. Take extra care in duct sealing and in duct-air flow improvements for electric furnaces because of the high cost of electricity.
4. Verify safety limits and temperature rise conform to manufacturer's specifications.

3.10.1 Cold-Climate Air-Source Heat Pump Installations

Advances in heat pump technology allow systems to provide heat even at temperatures down to -20 degrees Fahrenheit. Replacing electric baseboard heat with a cold-climate air-source heat pump can result in significant savings.

When installing a cold-climate air-source heat pump:

1. Properly size the system based on 47°F- and 5°F-certified output capacities and determine the need for back-up heating when the new equipment will not be sufficient to meet hourly heat load demands.
2. Ensure that all components are compatible with each other for either a mini-split ductless system or a fully ducted system, including properly sized refrigerant lines.
3. Locate outdoor components in a location to provide access for maintenance and to allow for unrestricted airflow.
4. Locate indoor components of a mini-split system in location to provide adequate distribution of delivered warm air.
5. Install a dedicated electrical circuit rated or fused to match the amperage of the system's requirements for overcurrent protection.
6. Install system in accordance with manufacturer's instructions and applicable state and local codes. Follow manufacturer's instructions for the proper removal of condensate.
7. Confirm that the system has the correct amount of refrigerant to operate correctly and efficiently.

3.11 Cooling Systems

The use of air conditioning has become more common in homes across Wisconsin. In recent years, higher annual cooling degree days (CDD) along with higher electric costs results in greater savings. This in turn may result in cost effective replacements that meet the minimum savings-to-investment ratio (SIR).

All replacement cooling systems shall meet the minimum efficiency standards as specified in the Wisconsin Weatherization Program Manual and listed in the AHRI Directory of Certified Product Performance. Observe the following standards for all cooling system replacements:

1. Install cooling systems in accordance with manufacturer's instructions and applicable state and local codes.
2. Properly remove and dispose of the existing unit.
3. Provide an owner's manual with cooling system replacements.
4. Properly size replacement cooling systems units using an accurate analysis through REScheck, ACCA Manual J, or an equivalent industry-accepted sizing procedure based on post-weatherization cooling load.
5. Provide in-home operation and maintenance instructions, including a review of safety precautions to the customer.

3.11.1 Central Air Conditioner Installations

1. Use the existing distribution system, A-coil, and refrigerant lines, when possible.
2. Replacement A-coil must match or be paired with outside condenser unit.
3. Properly evacuate refrigerant from lines and recycle/dispose of old refrigerant if not used in the new system.
4. Locate outdoor unit to allow for dissipation of heat and to provide access for maintenance. The condenser shall be placed on a secure fabricated equipment pad or poured concrete pad.
5. Install a dedicated electrical circuit rated or fused to match the amperage of the system's requirements for overcurrent protection.
6. Install a weather-proof disconnect box within proximity of outdoor unit. Ensure safety disconnect is fused at manufacturer's recommended amperage. Install UL listed disconnect whip from box to AC unit.
7. Install condensate tubing or piping to reach an appropriate drain. Utilize a hose protection ramp (trip strip) instead of a condensate pump where feasible.
8. Install a condensate pump when the condensate tubing will not drain adequately to an appropriate drain or may cause a tripping hazard. See *Condensate Removal in Chapter 3 – Section 3.8.2* for more information about condensate pumps.
9. Confirm system setup meets manufacturer's recommendations for refrigerant level, room supply air temperature, super-heat, and sub-cooling temperatures.

3.11.2 Room/Window Air Conditioner Installations

Room or through the wall air conditioners can provide cooling to targeted sections of homes when the entire home is not cooled. Prior to the replacement of multiple room air conditioners consider the installation of central AC, if feasible.

1. Locate units in windows/areas that will provide adequate distribution of cool air to sections of home that are to be cooled.
2. Window model selection should consider ease of installation/removal as well as the weight of the unit.
3. Properly support window units and seal around all openings not filled by units. Consider U-shaped models that provide proper support and allow the lower sash of window to be closed in a lower position.
4. Ensure opening/sleeves can be properly sealed during winter for room air conditioners.
5. Properly install unit to allow for drainage of condensate.
6. Ensure electrical outlet and circuit are rated for proper amperage of installed AC unit.

3.11.3 Air-Source Heat Pump Installations

Installing heat pumps rather than air conditioners can provide the needed cooling capacity and, in some homes, a significant portion of the needed heating capacity. Determine the most cost-effective outdoor temperature setting to switch to back-up heat, such as propane or oil forced air system. Provide customer education on the operating cost of the heat pump compared to the back-up heating system. Fully explain that additional electrical usage will be seen on bills when used for heating. Further explain that the cost of the electricity used by a heat pump can be lower than that of the back-up fuel when fossil fuel prices are higher.

3.11.3.1 Fully Ducted Installations

1. Use the existing distribution system, A-coil, and refrigerant lines, when possible.
2. Consider matching the inside coil and new refrigerant lines paired with condenser unit when existing will not meet needs or if new refrigerant requires updating.
3. Properly evacuate refrigerant from lines and recycle/dispose of old refrigerant where applicable.
4. Locate outdoor unit to allow for dissipation of heat and to provide access for maintenance. Condenser shall be placed on a secure fabricated equipment pad or poured concrete pad.
5. Install a dedicated electrical circuit rated or fused to match the amperage of the system's requirements for overcurrent protection.
6. Install a weather-proof disconnect box within proximity of outdoor unit. Ensure safety disconnect is fused at manufacturer's recommended amperage. Install UL listed disconnect whip from box to AC unit.
7. Install condensate tubing or piping to reach an appropriate drain. Utilize a hose protection ramp (trip strip) instead of a condensate pump where feasible.
8. Install a condensate pump when the condensate tubing will not drain adequately to an appropriate drain or may cause a tripping hazard. See *Condensate Removal in Chapter 3 – Section 3.8.2* for more information about condensate pumps.
9. Confirm system setup meets manufacturer's recommendations for refrigerant level, room supply air temperature, super-heat, and sub-cooling temperatures.

3.11.3.2 Mini-Split Ductless Installations

1. Locate outdoor components in a location to provide access for maintenance and to allow for un-restricted airflow. Place outdoor unit on a secure fabricated equipment pad or poured concrete pad.
2. Locate indoor components of a mini-split system in location to provide adequate distribution of delivered conditioned air.
3. Install a dedicated electrical circuit rated or fused to match the amperage of the system's requirements for overcurrent protection.
4. Follow manufacturer's instructions for the proper removal of condensate.

5. Confirm that the system has the correct amount of refrigerant to operate correctly and efficiently.

3.12 Replacing Space Heaters

When replacing a space heater:

1. Follow the manufacturer's venting instructions carefully. Do not vent sealed-combustion, induced-draft space heaters into naturally drafting chimneys.
2. If the space heater will sit on a carpeted floor, provide a fire-rated floor protector, sized to the width and length of the space heater, as a base.
3. Locate space heater away from traffic, draperies, and furniture.
4. Space heaters require a properly grounded duplex receptacle for electrical service.

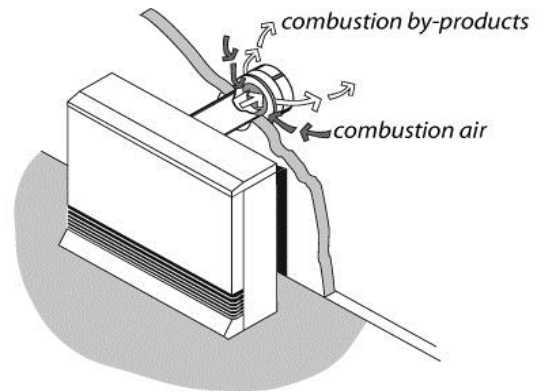

Sealed combustion space heater: A sealed combustion space heater draws combustion air in and exhausts combustion by-products through a concentric vent system using a draft fan.

Inform the customer of the following operating instructions:

1. Do not store any objects near the space heater that would restrict air flow around it.
2. Do not use the space heater to dry clothes or for any purpose other than heating the home.
3. Do not allow anyone to lean or sit on the space heater.
4. Do not spray aerosols near the space heater. Many aerosols are flammable or can cause corrosion to the space heater's heat exchanger.



Space heater controls: Many modern energy-efficient space heaters have programmable thermostats as standard features.

3.13 Replacing Wood Stoves

Wood stoves with a crack or hole in the firebox and units that do not meet clearances and cannot be corrected shall be replaced for health and safety of the occupants. All replacement wood stoves must meet applicable local codes and EPA requirements. Installations must conform to NFPA 211.

When replacing a wood stove:

1. Install the stove to meet manufacturer's specifications.
2. Verify the replacement stove is certified to meet EPA emission standards or local standards, whichever are stricter.
3. Confirm the installed unit is certified and labeled by:

- a. National Fire Protection Association under 211-1996, or
 - b. Other equivalent listing organization
4. Visually inspect the chimney for safe operation by referring to NFPA 211.
5. Provide all customers with in-home operation instructions, to include proper wood-burning practices, safety information, and education about proper maintenance, such as stack thermometers and the need for fire extinguishers.
6. Educate the customers about the potential impact of exhaust ventilation and/or forced-air distribution on the wood heater's operation.

Install make-up air if the building is tightened below the depressurization limit CFM₅₀.

3.14 Venting Combustion Gases

Proper venting is essential to the operation, efficiency, safety, and durability of combustion heaters. The National Fire Protection Association (NFPA) and the International Code Council (ICC) are the authorities on material choice, sizing, and clearances for chimneys and vent connectors, as well as for combustion air. The information in this venting section is based on the following NFPA and ICC documents:

- ✓ The International Fuel Gas Code (IFGC) (ICC)
- ✓ NFPA 31: Standard for the Installation of Oil-Burning Equipment
- ✓ NFPA 211: Standard for Chimneys, Fireplaces, Vents, and Solid-Fuel-Burning Appliances

Table 3-6: Guide to Venting Standards

Topic	Code Reference
Venting sizing	IFGC, Section 504
Clearances	IFGC, Section 308 and Tables 308.21 NFPA 31, Section 4-4.1.1 and Tables 4-4.1.1 and 4-4.1.2 NFPA 211, Sections 6.5, 4.3, 5
Combustion air	IFGC, Section 304 NFPA 31, Section 1-9 NFPA 211, Section 8.5 and 9.3

3.14.1 Improving Inadequate Draft

If spillage is detected, investigate the reason for the weak draft. Open a window, exterior door, or interior door that is below the level of the heating appliance to observe whether the addition of make-up air will improve draft. If the added air strengthens draft, then the problem is usually depressurization. If opening a window has no effect, inspect the chimney. The chimney could be blocked or excessively leaky.

Chimney Improvements to Solve Draft Problems

Consider the following chimney improvements when attempting to improve worst-case draft:

1. Remove chimney obstructions.
2. Repair disconnections or leaks at joints and where the vent connector joins a masonry chimney.
3. Measure the size of the vent connector and chimney and compare with vent-sizing information listed in Section 504 of the International Fuel Gas Code. A vent connector or chimney liner, either too large or too small, can result in poor draft.
4. Increase the pitch of horizontal sections of vent, to facilitate the flue gases' movement toward the chimney.
5. Extend the flue's roof-jack. This option may be especially useful when the appliance's exhaust stack is short — for example, in a mobile home, or in a ranch home on a slab.
6. If wind is causing erratic draft, consider installing a wind-dampening chimney cap. If the masonry chimney is deteriorated, consider installing a new chimney liner.

Duct Improvements to Solve Draft Problems

Consider the following duct and air flow improvements when attempt to improve worst-case draft:

1. Seal/remove any return grilles in the CAZ.
2. Install a sealing filter cover.
3. Seal return-duct leaks in the CAZ, using the Diagnostic Workbook to guide duct-sealing decision-making.
4. Isolate the furnace from its return registers by air sealing.
5. Install make-up air to the CAZ. Open a nearby window, exterior door, or interior door to observe whether the addition of make-up air will improve draft. If the open window or door improves draft to an acceptable level, measure the size of the opening, and install make-up air accordingly.

Table 3-7: Draft Problems and Solutions

Problem	Possible Solutions
Adequate draft never established	Remove chimney blockage, seal chimney air leaks, or provide additional combustion air as necessary.
Blower activation weakens draft	Seal leaks in the furnace and in nearby return ducts. Isolate the furnace from nearby return registers.
Exhaust fans weaken draft	Provide make-up or combustion air if opening a door or window to outdoors strengthens draft during testing.
Closing interior doors during blower operation weakens draft	Add return ducts, grilles between rooms, or jumper ducts.

3.15 Combustion Air

A combustion appliance zone is classified as either an **unconfined space** or as a **confined space as defined by the IFGC**. An unconfined space is a CAZ connected to enough building air leakage to provide combustion air. A confined space is a CAZ with sheeted walls and ceiling and a closed door that form an air barrier between the appliance and other indoor spaces.

For confined spaces, the IFGC prescribes additional combustion air from outside the CAZ. Combustion air is supplied to the combustion appliance zone in four ways.

1. To an unconfined space through leaks within the building.
2. To a confined space through an intentional opening or openings between the CAZ and other indoor areas where air transfers in to replenish combustion air.
3. To a confined space through an intentional opening or openings between the CAZ and outdoors or ventilated intermediate zones like attics and crawl spaces.
4. Directly from the outdoors to the confined or airtight CAZ through a duct. Appliances with their own direct combustion-air ducts are called **sealed-combustion** or **direct-vent** appliances.

Table 3-8: CFM Air Requirements for Combustion Furnaces or Boilers

Appliance	Combustion Air (CFM)	Dilution Air (CFM)
Conventional Oil	38	195
Flame-Retention Oil	25	195
High-Efficiency Oil	22	-
Conventional Atmospheric Gas	30	143
Fan-Assisted Gas	26	-
Condensing Gas	17	-
Fireplace (no doors)	100-600	-
Airtight Wood Stove	10-50	-
A.C.S. Hayden, Residential Combustion Appliances: Venting and Indoor Air Quality Solid Fuels Encyclopedia		

3.15.1 Unconfined Space Combustion Air

Combustion appliances located in most basements, attics, and crawl spaces get adequate combustion air from leaks in the building shell. Even when a combustion appliance is located within the home’s living space, it usually gets adequate combustion air from air leaks, unless the house is airtight or the combustion zone is depressurized.

3.15.2 Confined Space Combustion Air

A confined space is defined by the IFGC as a room containing one or more combustion appliances and which has less than 50 cubic feet of volume for every 1,000 BTUs per hour (BTU/hr) of appliance input.

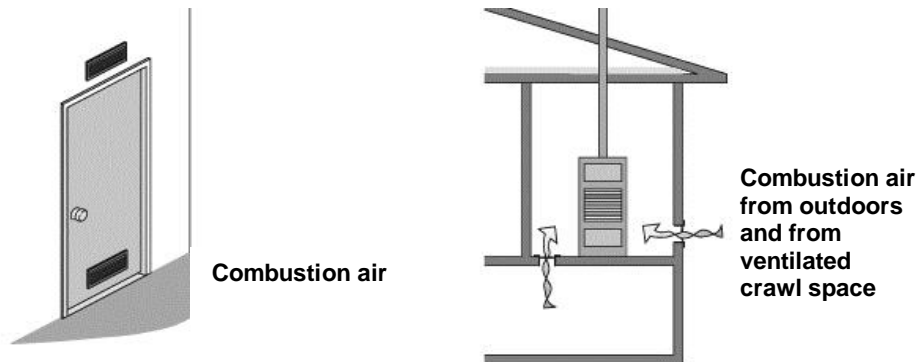

Passive combustion-air options: Combustion air can be supplied from adjacent indoor spaces or from outdoors. Beware of passive combustion-air vents into the attic that could depressurize a combustion zone or allow moist air to travel into the attic.

If a small mechanical room is connected to adjacent spaces through large air passages like floor-joint spaces, however, the CAZ may not need additional combustion air, even with sheeted walls and a door separating it from other indoor spaces. The extent of the connection between the CAZ and other spaces can be confirmed by worst-case draft testing or blower door testing.

On the other hand, if the home is unusually airtight, the CAZ may not be able to obtain adequate combustion air, even when the CAZ is larger than the minimum confined-space room volume, defined above.

In confined spaces or airtight homes where outdoor combustion air is needed, the best strategy is a single-vent opening installed as low in the CAZ as is practical. A combustion-air vent into an attic may depressurize the combustion zone or dump warm, moist air into the attic. Instead, connect the combustion zone directly to the outdoors or to a ventilated crawl space through a single low vent, if possible.

Choose an outdoor location that is sheltered, where the wall containing the vent is not parallel to prevailing winds. Wind blowing parallel to an exterior wall or at a right angle to the vent opening tends to depressurize both the opening and the CAZ connected to it. Indoors, locate combustion-air vents away from water pipes to prevent the pipes from freezing.

3.15.3 Net-Free Area

Net-free area is the surface area of venting that remains open after subtracting for the blocking effect of louvers and grilles. Metal grilles and louvers are assumed to reduce the size of the vent opening to 75 percent of the original surface area. Wooden grilles and louvers are more

restrictive, and they are assumed to reduce the net-free area to 25 percent of the original surface area.

Manufacturers often provide specifications about the net-free area through their grilles and louvers. When this information is available, use it to calculate the size of opening required to provide the net-free area necessary. When these specifications are not available, use the assumptions listed above.

For example, calculate a 10-inch by 10-inch opening (100 square inches) with a metal grille attached as having 75 square inches of net-free area. With a wooden louver installed, to calculate the same opening use 25 square inches of net-free area.

When sizing vent openings, always account for the reduction in the net-free area that will occur due to the installation of grilles and louvers.

3.15.4 Sizing Combustion-Air Openings

Table 3-9 summarizes the required ratios of combustion-air net-free area to appliance input (BTU/hr).

Here is an example of sizing two direct combustion-air openings to adjacent indoor space: The furnace and water heater are located in a confined space. The furnace has an input rating of 100,000 BTU/hr. The water heater has an input rating of 50,000 BTU/hr. Combined, the two appliances have an input rating of 150,000 BTU/hr. Therefore, each opening must have at least 150 square inches of net-free area of venting between the mechanical room and adjacent indoor space ($150,000 \div 1,000 = 150$ sq. in.). There are two openings, so the CAZ will have a total of 300 square inches of net-free area of venting.

If the same CAZ were ducted to the outdoors with a single opening, the requirement for the net-free area of venting would decrease to 50 square inches ($150,000 \div 3,000 = 50$ sq. in.).

When installing two combustion-air openings, the IFGC usually requires one opening commences 12 inches from the ceiling and one opening 12 inches from the floor. See IFGC 2012, Section 304.5 for a full breakdown of combustion-air requirements.

Table 3-9: Combustion Air Openings: Location and Size

Location	Dimensions
Two direct openings to adjacent indoor space	Minimum area each: 100 in ² 1 in ² per 1000 BTU/hr each combined rooms volumes must be ≥S 50 ft ³ per 1000 BTU/hr
Two direct openings or vertical ducts to outdoors	Each vent should have 1 in ² for each 4,000 BTU/hr
Two horizontal ducts to outdoors	Each vent should have 1 in ² for each 2,000 BTU/hr
Single direct or ducted vent to outdoors	Single vent should have 1 in ² for each 3,000 BTU/hr
From the <i>International Fuel Gas Code (IFCG)</i> .	

3.16 Thermostats

Set the thermostat’s heat anticipator to the amperage measured in the control circuit or follow the thermostat manufacturer’s instructions for adjusting cycle length.

3.16.1 Programmable and Smart Thermostats

Programmable and smart thermostats may be big energy savers if the occupants understand how to operate the thermostat. If the existing thermostat will be replaced as a part of the weatherization work, discuss this option with the occupant. If the occupant is willing to use a programmable or smart thermostat, proceed with the installation. Educate the occupant on the use of the thermostat and leave a copy of manufacturer’s directions with them.

Final Inspection and Quality Assurance Standards

Heating system work shall meet the following standards.

Required Outcomes		
	Replacements	Clean and Tune
All Fuels and Types	1. The carbon monoxide concentration in the undiluted flue gas does not exceed 400 ppm air-free <i>or</i> is within manufacturer's specifications.	1. The carbon monoxide concentration in the undiluted flue gas does not exceed 400 ppm air-free <i>or</i> is within manufacturer's specifications.
Gas Systems	2. Test and set the gas pressure within the manufacturer's specifications.	2. Test and set the gas pressure within the manufacturer's specifications.
Oil Systems	3. The smoke test: ≤ 1 for flame retention burner systems and ≤ 2 for non-flame retention burner systems using a smoke-spot scale.	3. The smoke test: ≤ 1 for flame retention burner systems and ≤ 2 for non-flame retention burner systems using a smoke-spot scale.
Forced-Air	4. The temperature rise is within the manufacturer's specification.	4. The temperature rise is within the manufacturer's specification.
All Boilers	5. O ₂ and CO (or CO ₂) values are within manufacturer's specified range. 6. Non-condensing boiler: The stack temperature is at least 300°F to minimize condensation in the chimney.	5. O ₂ and CO (or CO ₂) values are within manufacturer's specified range. 6. Non-condensing boiler: The stack temperature is at least 300°F to minimize condensation in the chimney.
$\geq 90\%$ Boilers	7. Outside air temperature sensor is installed on a north-facing exterior wall. 8. Heating curve is programmed in line with the dwelling's heat loss and radiation capacity.	7. Outside air temperature sensor is installed on a north-facing exterior wall. 8. Heating curve is programmed in line with the dwelling's heat loss and radiation capacity.

Heating Systems – General

1. Heating System Check List is complete in file.
2. Condensate line:
 - a. Drains properly and is secured to floor drain.
 - b. Does not present a tripping hazard.
 - c. Pump installed only when needed.
3. No fuel leaks.
4. Oil systems have a new oil filter.
5. No pre-existing unvented space heaters located within the living space or pressure boundary remain in place.
6. Bonding of CSST gas lines meets NFPA 54 standards.

Required Testing		
	Replacements	Clean and Tune
All Fuels and Types	1. Measure the steady-state efficiency (SSE).	1. Measure the steady-state efficiency (SSE).
	2. Measure oxygen (O ₂) levels. See <i>Table 3-2, Typical Ranges for Gas-Burning Equipment</i> .	2. Measure oxygen (O ₂) levels. See <i>Table 3-2, Typical Ranges for Gas-Burning Equipment</i> .
	3. Measure the stack temperature (T-Stack).	3. Measure the stack temperature (T-Stack).
Forced-Air	4. Measure the air flow of the furnace air handler. Use a flow plate or the manufacturer's fan-flow tables to calculate air flow.	4. Measure the air flow of the furnace air handler. Use a flow plate or the manufacturer's fan-flow tables to calculate air flow.
All Boilers	5. Measure the supply and return water temperatures.	5. Measure the supply and return water temperatures.

New Heating Systems

1. Heating system is properly sized and adequately heats the building.
 - a. Sizing calculation is in the customer file that accurately reflects the heat loss of the post-weatherization building.
 - b. Distribution system is adequate for the properly sized furnace.
2. Heating system has proper venting.
 - a. Meets manufacturer and code requirements.
 - b. Proper clearances from windows, doors, and 3 feet from a gas meter, regulator, and vent outlet.
3. System is raised off the floor by durable materials.
 - a. For basements with known water problems, the height is based on typical high-water marks noted in the CAZ or based on customer input.
4. Heating system equipment meets specification requirements.
5. Building permit obtained as required.
6. Installation meets code requirements.
7. System is on a dedicated electrical circuit.
 - a. Service disconnect is present or within line-of-sight at service panel.
 - b. Circuit is properly sized or a fuse or breaker is installed to protect the system.
8. The warranty and/or manual booklet is posted on or near the furnace.
9. Installed wood systems or stoves comply with NFPA 211 or EPA (per label).

Forced-Air Distribution

1. Filter/compartiment:
 - a. Is properly sealed, tight cover fit, and the filter seals to the filter rack.
 - b. Allows for easy filter replacement.
 - c. Filter is MERV 6 or better.
 - d. One cleanable filter, six disposable 1- to 2-inch filters included, or one 3-inch filter installed.
2. Distribution within the CAZ and living areas are sealed based on worst-case depressurization testing. The distribution system does not excessively depressurize the CAZ, (>1 pascal, based on warnings in the Diagnostic Workbook when Category I appliances are present).
3. Adequate heat and return air are provided in the living areas.
4. New supply and return ducts are the proper size for efficient operation of the heating system.
5. Duct joints are properly attached and secured.

6. Ducts are properly supported.
7. Metal ducts are sealed with a UL181 rated material like mastic, tape, or caulk.
8. Distribution work in unheated areas is insulated to minimum of R-8.
9. Insulation meets material specifications and is not compressed.
10. Fiberglass insulation is installed with mechanical fasteners.
11. Registers are properly functioning for their intended purpose.
12. There are no return grilles in the CAZ.
13. New supply ducts have dampers.
14. Mobile home return air system is centralized through living space.
15. Back-draft dampers are installed between a wood furnace plenum and another forced air system.

Boilers

1. Boiler size is properly calculated and includes domestic hot water when applicable.
2. Existing radiators and other terminal devices are the appropriate size and quantity for the spaces they heat.
3. Heating System Check List is complete and in file.
4. Replacement units are rated for the application.
5. The existing feed water and distribution system works properly with a new boiler.
6. Distribution system was properly flushed.
7. Boiler controls, auto-fill valve, zone valve, and expansion tank are present and functioning as designed and outdoor air temperature sensor is installed on the most north facing exterior wall.
8. Existing boiler or distribution is adjusted or modified properly.
9. Radiators are bled and there no air is in the system.
10. Pressure relief valve has been documented as opened; closes without leaking.
11. Three- and four-unit buildings only. Boiler registration number is posted with current state certified inspection.

Hot Water Space Heating Distribution

1. Pipes are insulated in unheated areas.
2. Insulation seams are tightly fitted and secured.
3. No leaks in the system.

Thermostats

1. Installed thermostat functions properly with the installed heating system and meets household needs.
2. Customer is educated and understands how to operate thermostat.
3. Thermostat is in a location that allows the heating system to operate properly to heat the space.
4. Thermostat is installed on an interior wall and not near a supply register.

Additional Considerations

Under certain circumstances, the following items may be necessary to verify other tests results are correct or for troubleshooting various problems.

Air flow through the flow meter is consistent with flow rate listed in *Table 3-1* and the manufacturer's fan tables.

Required Testing		
	Replacements	Clean and Tune
All Fuels and Types	1. Measure the steady-state efficiency (SSE).	1. Measure the steady-state efficiency (SSE).
	2. Measure oxygen (O ₂) levels. See <i>Table 3-2, Typical Ranges for Gas-Burning Equipment</i> .	2. Measure oxygen (O ₂) levels. See <i>Table 3-2, Typical Ranges for Gas-Burning Equipment</i> .
	3. Measure the stack temperature (T-Stack).	3. Measure the stack temperature (T-Stack).
Forced-Air	4. Measure the air flow of the furnace air handler. Use a flow plate or the manufacturer's fan-flow tables to calculate air flow.	4. Measure the air flow of the furnace air handler. Use a flow plate or the manufacturer's fan-flow tables to calculate air flow.
All Boilers	5. Measure the supply and return water temperatures.	5. Measure the supply and return water temperatures.

Chapter 4: Base Load Measures

Base load measures are energy conservation measures that affect non-space heating energy usage. These measures may include, but are not limited to:

1. Water heater replacement
2. Domestic hot water treatments
3. Refrigerator and freezer replacement or removal
4. Lighting retrofits
5. Clothes washer replacement

4.1 Water Heater Replacement

Energy conservation replacements typically occur by completing conversions to natural gas from another fuel type, conversions to a hybrid heat pump from electric, or by replacing the existing inefficient water heater.

Observe the following standards for all water heater replacements or removals:

1. Remove existing water heater and dispose of properly.
2. Size the replacement water heater properly, based upon the number of people in the building.
3. Ensure height and space is acceptable for the water heater replacement.
4. Assess venting options for non-electric water heater replacements to ensure venting meets code requirements.

Observe the following standards for water heater installations:

1. Install water heater per manufacturer's instructions on a level and stable location. Provide strapping to secure the water heater, if needed.
2. Install a temperature and pressure relief (TPR) valve with piping as required by code or local jurisdiction.
3. Ensure venting meets NFPA 54 for gas units.
4. Install a dedicated shut-off valve for fuel supply.
5. Install a dedicated shut-off valve for both the hot and cold water lines to allow isolation of the tank, if none exist.
6. Ensure water lines do not leak after connection to water heater.
7. Fill tank with water before turning water heater on.
8. Measure and adjust temperature settings to 120°F. Check delivered temperature and adjust as necessary.
9. Affix a tag to the water heater identifying whom the customer should call for warranty

service. Display the tag prominently, and confirm that it includes the service provider's name, address, and telephone number.

10. If an existing outlet is not present, install an electrical outlet per manufacturer's instructions (pmi) and/or local codes. When a difference between the manufacturer specifications and code exists, the more restrictive requirement shall be applied.

4.1.1 Gas Water Heater Installations

Observe the following standards for all gas water heater installations:

1. Follow the manufacturer's instructions and NFPA 54 to ensure proper venting of the new water heater.
2. Confirm no gas leaks exist in any of the gas piping.
3. Install a proper sediment trap on gas line, if none exists.
4. Install an approved shut-off valve on the gas line, if none exists.
5. Install gas pipe that is supported and electrically bonded (if required) in accordance with NFPA 54 and the WI Uniform Dwelling Code. Follow the manufacturer's specifications for installation. For more information, see NFPA 54 and WI SPS 323.16.
 - a. When CSST is already present in the building and not correctly bonded, bond the gas piping system to the electrical ground in accordance with NEC 250.94 and 250.104 when completing work on the fuel supply and/or the water heater.
6. Install properly sized gas piping.
7. A UL-listed appliance connector may be used to connect gas valve to gas piping.
8. Measure and adjust gas pressure to meet manufacturer's instructions.
9. Test for carbon monoxide (CO) level in the flue prior to the addition of dilution air, if possible, to confirm the CO level is less than 200 ppm air-free (or meets manufacturer's specifications, if different).

Observe the following standards for power-vented gas water heater installations:

1. If an existing outlet is not present, install an electrical outlet pmi and/or local codes. When a difference between the manufacturer specifications and code exists, the more restrictive requirement shall be applied.
2. Follow manufacturer's instructions for the proper removal of condensate.

4.1.2 Electric Water Heater Installations

Observe the following standards for all electric water heater installations:

1. Follow the manufacturer's instructions and current NEC code to ensure proper electrical connections.
2. Ensure circuit is protected by the correct fuse or breaker amperage.

Observe the following standards for heat pump water heater installations:

1. Follow the manufacturer's instructions for proper removal of condensate.
2. Educate the customer on how to change operational mode.
3. Educate the customer about how and when to change the filter.
4. Follow the manufacturer's instructions when venting cooler exhaust air to the outdoors.

4.2 Domestic Hot Water Treatments

4.2.1 Water Saving Showerheads and Aerators

1. Remove and replace existing showerheads and aerators rated or tested above 1.5 gallons per minute with showerheads and aerators rated at 1.5 gallons per minute or less, and recycle replaced items appropriately.
2. Install new showerheads using thread-seal tape or other pipe sealant to prevent leakage. Avoid overtightening the new showerhead.
3. Protect the curved chrome showerhead nipple from damage during installation, using cloth or leather between the jaws of the pipe wrench or pliers.
4. When replacing faucet aerators, be careful to avoid scratching or deforming them.
5. Be cautious when significant deposits exist on the devices as this could lead to fixture damage and additional costs.

4.2.2 Water Heater Pipe Insulation

1. **FOR MOBILE HOMES ONLY:** For water heaters located in a closet with exterior access, insulate all water piping in the closet.
2. Insulate all pipes on the circulating loop between a boiler and an indirect domestic hot water storage tank.
3. Use properly sized pipe insulation rated at R-3 or better. Insulate elbows, unions, and other fittings to the same thickness the straight pipe runs are insulated.
4. Keep pipe insulation at least six inches away from combustion vent pipe, unless the insulation has a fire safety rating for closer clearance.
5. Secure seams, joints, and ends of pipe sleeves.

4.2.3 Setting or Reducing Water Temperature

1. Measure the hot water temperature at the faucet nearest to the water heater and set or reduce the water heater temperature to 120°F, with customer permission.
2. Mark the current setting on the thermostat and move the control to a lower temperature. Note the difference between electric and gas controls shown here.

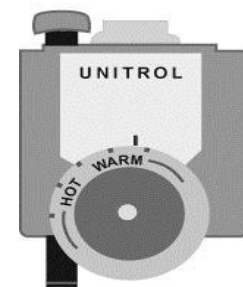

Gas water heater control



Electric water heater control

3. On electric water heaters, set the upper thermostat and lower thermostat to the same temperature. Shut off power to the water heater before opening thermostat access panels.

4.3 Refrigerator or Freezer Replacement and Removal

Prior to installing a replacement unit:

1. Install replacement units only in locations allowed per manufacturer's instructions. Units can be installed in a non-conditioned space if allowed by the manufacturer.
2. Confirm the replacement unit will fit in the existing opening without modifications. Modify the opening only with agency and customer approval.
3. Verify door openings are wide enough to accommodate a new unit installation.
4. For units that do not meet Wisconsin Weatherization Program replacement guidelines, confirm the required waiver documentation is in the customer file.

When replacing a refrigerator or freezer:

1. Install the replacement unit level for proper operation. Raise the front of a refrigerator slightly to allow the doors to close slowly and without assistance or with limited assistance from the customer.
2. Unless limited by the existing installation space, install all the parts and trim per the manufacturer's instructions.
3. Plug the unit into the nearest receptacle to confirm the unit functions. Do not plug into an extension cord. The outlet should not be on a ground-fault interrupter circuit.
4. Change the swing on doors, if necessary, to meet the needs of the customer.
5. Verify the doors are properly aligned and seal tightly with a positive gasket seal.
6. De-manufacture and properly dispose of existing units being removed or replaced. Do not disable the existing unit until you install the replacement and confirm it works properly.

4.4 Lighting

Light Emitting Diode (LED) bulbs typically use 75 percent less electricity than a standard incandescent bulb. To prevent customer removal and promote efficiency, replacement LED bulbs should be selected to provide light output (lumen, efficacy, and color) equivalent to existing incandescent bulbs.



Globe-style LED

Halogen torchiere lamps pose a health and safety risk due to the heat generated by the halogen bulb. Replacing these lamps with an LED model eliminates the health and safety risk and reduces electrical usage.

When replacing lighting:

1. Demonstrate LED lighting. Explain the related electric savings potential for customers unsure about replacing incandescent bulbs with LEDs.
2. Select replacement LED bulbs with wattage that matches the lumen output and functionality of the existing incandescent bulb. Confirm customer satisfaction for task lighting and background lighting.
3. Install all LEDs. LEDs shall not be left for the customer to install.
4. Turn on each LED lighting replacement after installation to confirm it works properly.
5. Replace halogen torchiere lamps with LED torchiere lamps when appropriate and remove halogen torchiere lamps from residence. Properly dispose of halogen torchiere lamps.
6. Existing CFLs shall not be replaced with LEDs.
7. Provide CFL clean up instructions to customers.
8. Proper disposal is required.

If a CFL breaks, take care in cleaning up. Even though the amount of mercury is very small, EPA recommends the following steps:

1. Open nearby windows to disperse any vapors and leave the room for 15 minutes.
2. Carefully scoop up the fragments and powder with stiff paper or cardboard and seal them in a plastic bag.
3. Wipe the area clean with damp paper towels and place in the plastic bag.
4. Do not use a vacuum or broom to clean up the broken bulb on hard surfaces.
5. Place all clean-up materials in a sealed plastic bag.
6. Place the bag in a second sealed plastic bag and place it in an outdoor trash container.
Note: Broken and unbroken CFLs should be taken to a recycling center if possible.
7. Wash your hands after disposing of the bag.

If a fluorescent bulb breaks on a rug or carpet, do your best to remove all visible materials using the steps above. Use sticky tape such as duct tape to help pick up the small pieces and powder. If you need to vacuum, once all visible materials have been removed, remove the vacuum bag (or empty and wipe the canister) and place the bag or vacuum debris in two sealed plastic bags and dispose of at your local hazardous waste site.

4.5 Clothes Washer

1. Make arrangements directly with the customer (as directed by the Agency) to schedule delivery and/or pick-up, or when needed to address any warranty/call back issues.
Provide a minimum of 24 hours' notice when scheduling with customer.
2. Per work order specifications, deliver to intended address(es) in the dwelling. Deliver to and install in same location as the existing unit(s). This may include installation in

individual apartments in multi-unit buildings.

3. Install with a drain pan/tray if the laundry room is on the second floor of the building, with finished living space on the level below the laundry room.
4. Install the replacement unit in place of the removed appliance, following manufacturer's specifications. Level unit, connect plumbing and accessories. Ensure the supply connections do not leak. Ensure the drain hose is installed to discharge to an appropriate outlet: a floor drain, standpipe, or laundry sink. Ensure the drain hose is secured as necessary.
5. Plug the unit into the nearest outlet and confirm the unit functions. Do not plug into an extension cord. Connect to a circuit with a ground-fault circuit interrupter (GFCI) if one is already installed and available.
6. Confirm the installed replacement unit works properly before disabling the existing unit.
7. Vendor is responsible for removal from premises and disposal of all debris, packing material, etc.
8. Remove the clothes washer identified for removal per the work order.
9. Vendor is responsible for any damage related to delivery, installation of new unit, or removal of old unit.
10. Appliances removed shall not be reused or resold. Disposal records shall be maintained sufficiently for vendor to provide verification to agency of proper disposal of any unit removed, upon agency request.

Final Inspection and Quality Assurance Standards

Acceptable installations shall meet the following standards.

Water Heater Replacement

1. Replacement is ENERGY STAR rated where applicable and meets the required Energy Factor (EF) or Uniform Energy Factor (UEF).
2. Follows Wisconsin Weatherization Program protocol for water heater replacement and was properly modeled with the energy audit.
3. Unit is properly sized for the household.
4. Follows manufacturer's instructions for installation including venting, pressure relief, drain tube, and electrical connection.
5. New outlet (receptacle) is properly installed per and/or local code.
6. Temperature measured is 120-125°F, unless an owner request for a higher temperature is documented. Do not set the water heater temperature below 120°F.
7. Replacement unit is not leaking or back drafting.

Water Saving Devices

1. Installation follows Wisconsin Weatherization Program policies and protocol.
2. New aerators and showerheads do not leak.
3. Recycle or properly dispose of replaced showerheads and faucet aerators.

Refrigerators

1. Installation meets the manufacturer's instructions.
2. All parts and trim are present and installed as designed.
3. Unit is properly sized for the household.
4. Doors are properly aligned and there is a positive gasket seal.
5. The new refrigerator is installed as close to level as possible.
6. The unit consuming the most electricity (pre-weatherization) was replaced.
7. The refrigerator replaced was removed from the dwelling and disposed of properly.
8. Replacement refrigerator follows Wisconsin Weatherization Program policies and protocol.
9. The customer file contains a waiver for any unit that falls outside of replacement guidelines.

Freezers

1. Installation meets the manufacturer's instructions.
 - a. Unit is not installed in a non-conditioned space (garage, porch) unless allowed by the manufacturer.
2. All parts and trim are present and installed as designed.
3. Replacement freezer size is equal to or less than unit or units replaced.
4. Lid is properly aligned and there is a positive gasket seal.
5. The unit consuming the most electricity (pre-weatherization) was replaced.
6. The freezer replaced was removed from the building and disposed of properly.
7. Replacement freezer follows Wisconsin Weatherization Program policies and protocol.
8. Additional functional units were removed and a bounty was offered per program policy with owner's permission.

Lighting: LEDs

1. Follows Wisconsin Weatherization Program protocol and policies.
2. Replacement bulbs are appropriate for the intended use.
3. No uninstalled LEDs were left at job site.
4. All halogen torchiere lamps were replaced.

Clothes Washer

1. Installation meets manufacture's specifications.
2. Unit installed in the same location of the existing appliance.
3. Unit leveled and plumbing connections are appropriately connected.
4. Drain hose is attached to appropriate termination.
5. Unit is plugged into closest outlet (no extension cords may be used).
6. Confirm new appliance is operable.
7. Replaced clothes washer was removed.

Chapter 5: Health and Safety

This chapter addresses some of the most pressing health and safety hazards households face, as well as those faced by weatherization professionals while auditing, installing measures, or inspecting completed work. When serious safety problems are discovered in a home, field staff should inform an immediate supervisor and the customer about the hazards. Major hazards and potentially life-threatening conditions should be corrected prior to weatherization work beginning unless the installers are making the corrections as part of their work.

See *Health and Safety Inspection Check List* and the *Release of Liability Form* located via link on the Home Energy Plus website, <https://energyandhousing.wi.gov>.

Weatherization workers should be aware of the potential causes of on-site injuries and how awareness and precautions can reduce them. Examples of potential causes include, but are not limited to:

- ✓ Slips, trips, and falls
- ✓ Extreme temperatures
- ✓ Improper tool use
- ✓ Combustibles (materials or gases)

If an emergency occurs in the field, follow the agency safety policy or dial 911. When working, weatherization professionals must follow all applicable health and safety protocols per Occupational Safety and Health Administration (OSHA) and/or the local jurisdiction having authority.

Before beginning work, assess work areas for health and safety hazards to the workers and to the customer. Resolve any hazards either before work begins or during the work process. If hazards cannot be resolved, the home may require deferral until the hazards are addressed.

Inspect all tools for safety and use in accordance with manufacturer's specifications.

5.1 Personal Protective Equipment

On almost a daily basis, weatherization workers find themselves in situations that necessitate the use of personal protective equipment (PPE). The employer is required to provide workers with proper PPE needed to complete their jobs.

Examples of such PPE include, but are not limited to:

- ✓ Disposable coverall garments
- ✓ NIOSH approved respirators with annual fit test (and medical documentation, if required)
- ✓ Eye and face protection
- ✓ Confined-space supplied air and ventilation

- ✓ Hearing protection
- ✓ Fall protection

5.2 Safety Data Sheet (SDS)

The SDS for a product or material contains data about material specifications and safety information. This includes information about:

- | | |
|--|---------------------------------------|
| 1. Product and company/manufacturer | 9. Physical and chemical properties |
| 2. Hazards identification | 10. Chemical stability and reactivity |
| 3. Composition and ingredients | 11. Toxicological effects |
| 4. First aid | 12. Ecological information |
| 5. Firefighting | 13. Disposal |
| 6. Accidental release | 14. Transport considerations |
| 7. Handling and storage | 15. Regulatory information |
| 8. Exposure controls and personal protection | 16. Other |

All SDS for weatherization products can be accessed through the Home Energy Plus Training and Technical Assistance website. When possible, materials that create long-term health risks for the customer and workers should be replaced with materials that present less risk.

5.3 Confined Spaces

Weatherization professionals commonly work in small spaces such as crawl spaces and attics that can be defined by OSHA as a confined space. A confined space is large enough and so configured that an employee can bodily enter and perform assigned work but has limited or restricted means for entry or exit and is not designed for continuous employee occupancy.

A sign shall be posted at the entry of the crawl space access including the installers contact information along with any pertinent information related to the work completed.

All work performed within a confined space shall be performed in accordance with OSHA standard 29 CFR Part 1926 Subpart AA Final Rule.

5.4 Source Pollutant Control

The control of pollutants at the source is always the best solution, especially in homes with a lower measured CFM₅₀ reading. Whole-building mechanical ventilation helps remove and dilute low levels of pollutants. Technicians should be mindful of pollutant sources and exposures while performing weatherization.

The customer has significant control over the introduction and spread of many home pollutants. Always provide education to the customer about corrective actions they can take to minimize pollutants in their homes.

5.4.1 Carbon Monoxide (CO)

The EPA's suggested maximum eight-hour exposure limit for CO is nine parts per million (ppm) in room air. CO at or above nine ppm is often linked to malfunctioning combustion appliances within the living space.

Sources of Carbon Monoxide

CO pollution is often linked to unvented combustion appliances, back-drafting combustion appliances, gas ranges, charcoal grills, and motor vehicles idling in attached garages or near the home.

Testing for Carbon Monoxide

The most common CO testing instrument is an electronic sensor with a digital readout in parts per million (ppm). The readings will be either *AS MEASURED* or *AIR FREE*. Follow the manufacturer's recommendations on zeroing the meter — usually by exposing the meter to outside air. CO testing equipment typically requires recalibration every six months, using factory-specified procedures.

A CO test is normally completed in the appliance exhaust flue or at the exhaust port of the heat exchanger. Elevated CO can be caused by any of the following:

1. Overfiring of an appliance — too much combustion fuel is supplied to the appliance. A low O₂ percentage on a combustion analyzer indicates the appliance may be overfiring. Technicians may determine if the appliance is overfiring by clocking the gas meter.
2. Inadequate combustion air — occurs when a combustion appliance is lacking sufficient combustion air.
3. Back drafting/spillage of combustion gases suppressing the flame.
4. Flame interference by an object (a pan over a gas burner on a range top, for example).
5. Misalignment of the burner.

Appliance service technicians should strive to identify and correct these problems.

5.4.2 Carbon Monoxide (CO) Alarms

Follow these instructions when installing CO alarms:

1. Install according to the manufacturer's instructions. Leave the manufacturer's instructions with the customer.
2. Educate the customer about the purpose and features of the alarms including what to do if the alarm sounds.

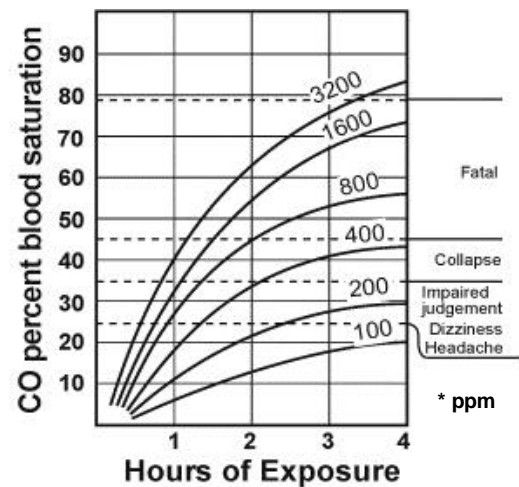

Effects of CO: This graph's curves represent different exposure levels in parts per million (ppm).

3. Batteries must be internal, non-replaceable, and have a 10-year manufacturer's warranty.
4. Install a CO alarm (if none are present or existing are non-functional), per NFPA 72:
 - a. On the ceiling in the same room as permanently installed fuel-burning appliances.
 - b. Centrally located on every habitable level and in every HVAC zone of the building.
 - c. Outside of each separate dwelling unit, within 21 ft of any door to a sleeping room.
 - d. Other locations where required by applicable local code.

Do not install CO alarms:

- ✓ In a room that may get too hot or cold for the alarm to function properly.
- ✓ Within 5 feet of a combustion appliance, vent, or chimney.
- ✓ Within 5 feet of a storage area for vapor-producing chemicals.
- ✓ Within 12 inches of exterior doors and windows.
- ✓ Inside of a furnace closet or room.
- ✓ With an electrical connection to a switched circuit.
- ✓ With a connection to a ground-fault interrupter circuit (GFCI).
- ✓ Behind furniture or appliances.

The manufacturer's instructions may specify stricter standards than these. If a conflict exists, follow the stricter specification.

5.4.3 Smoke Alarms

Follow these instructions when installing smoke alarms:

1. Install according to the manufacturer's instructions. Leave the manufacturer's instructions with the customer.
2. Educate the customer about the purpose and features of the alarms including what to do if the alarm sounds.
3. Batteries must be sealed, non-replaceable and have a 10-year manufacturer's warranty.
4. Install a smoke alarm (if none are present or existing are non-functional) on each floor, including the basement, and in the vicinity of sleeping area(s).

Do not install smoke alarms:

- ✓ Within 12 inches of exterior doors and windows.
- ✓ On a switched circuit, if hard-wired.
- ✓ On a ground-fault interrupter circuit (GFCI).

The manufacturer's instructions may specify stricter standards than these. If a conflict exists, follow the stricter specification.

5.4.4 Moisture Problems

Water and water vapor damages building materials by promoting mold and rot, dissolving glues and mortar, corroding metal, and nurturing pests like termites and dust mites. These pests, in turn, cause many cases of respiratory distress.

Water and moisture reduce the thermal resistance of insulation and other building materials. The most common sources of moisture are leaky roofs and damp foundations and basement floors. Other critical moisture sources include unvented dryers, showers, cooking appliances, and unvented gas appliances like ranges or decorative fireplaces.

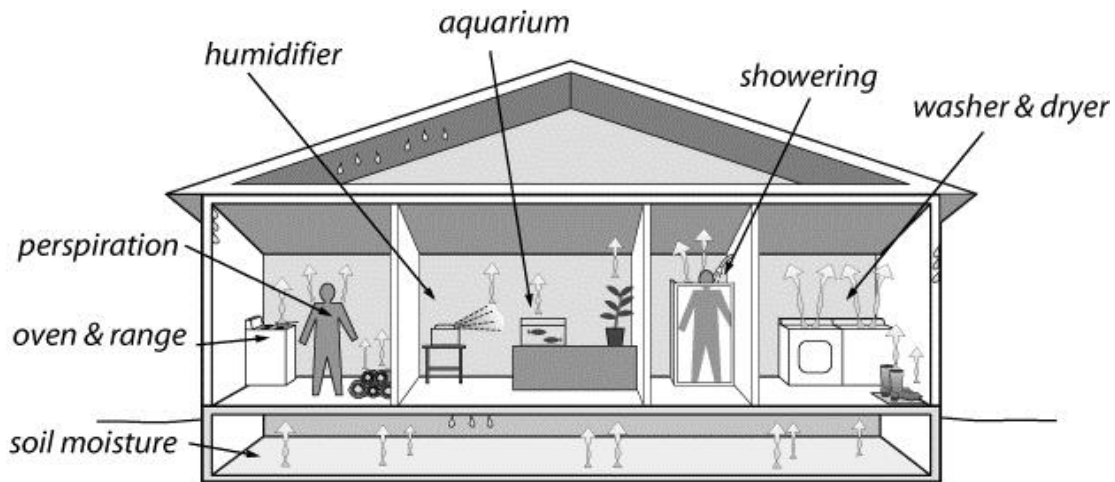

Moisture sources: Household moisture can often be controlled at the source by informed and motivated customers. Indoor relative humidity should be between 30-50 percent.

Identifying and reducing sources of bulk/liquid moisture is the first priority for solving moisture problems. The next priority is to install or repair air and vapor barriers to prevent moisture from migrating into and through building cavities. Local exhaust fans located in the kitchen and bathrooms will remove high levels of moisture and other pollutants at the source.

Table 5-1: Moisture Sources and their Potential Contributions

Moisture Source	Potential Amount Pints
Ground moisture	0-105 per day
Seasonal evaporation from materials	6-19 per day
Dryers venting indoors	4-6 per load
Dishwashing	1-2 per day
Cooking (meals for four)	2-4 per day
Showering	0.5 per shower

Relative humidity (RH) is a measurement of the degree to which air is saturated with moisture. Air at 100 percent RH is completely saturated. Home air below 30 percent RH is uncomfortably dry for many people. Air above 50 percent RH is likely to cause condensation on cold interior surfaces and in building cavities when outdoor weather is cold.

Symptoms of Moisture Problems

Condensation on windows, walls, and other surfaces may signal high RH and the need to find and reduce moisture sources. During very cold weather or rapid weather changes, condensation may occur. This occasional condensation is not a major concern. However, if window condensation is a persistent problem, reduce moisture sources, add insulation, or consider other remedies that lead to warmer interior surfaces. The colder the outdoor temperature, the more likely condensation will occur. Adding insulation helps eliminate cold areas where water vapor condenses.

Moisture problems arise when the moisture content of building materials reaches a threshold that allows pests like termites, dust mites, rot, and fungus to thrive. Asthma, bronchitis, and other respiratory ailments can be exacerbated by moisture problems because mold, mildew, and dust mites are potent allergens. The level of moisture problem can be determined by the current state of the existing building materials. The following are examples how moisture affects building materials:

1. Rot and wood decay indicate advanced moisture damage. Unlike surface mold and mildew, wood decay fungi penetrate, soften, and weaken wood.
2. Peeling, blistering, or cracking paint may indicate moisture is moving through a wall, damaging the paint and possibly the building materials underneath.
3. Corrosion, oxidation, and rust on metal are unmistakable signs moisture is at work. Deformed wooden surfaces may appear as damp wood swells and then warps and cracks as it dries.
4. Concrete and masonry efflorescence often indicates excess moisture at the home's foundation. Efflorescence is a white, crystalline deposit left by water that moves through masonry leaving behind minerals from mortar or the soil as it evaporates.

5.4.5 Foundation Moisture Control

Moisture and pollutants entering the home through foundations, basements, and crawl spaces can be a substantial contributor to indoor humidity and affect the indoor air quality, even when no wet areas are apparent. The pollutants and moisture can move easily through the home, driven by stack effect and by wicking of the moisture into permeable wood and concrete.

Ground Moisture Barriers

Air, moisture, and pollutants can move through soil and into crawl spaces and dirt-floor basements. Even soil that seems dry at the surface can release a lot of moisture into the home.

Follow these instructions when installing a ground vapor retarder to control the movement of

moisture and soil gases:

1. Inspect all plumbing for leaks and repair any leaks found before installing the ground vapor retarder.
2. Cover the ground completely with an airtight barrier, such as 6-mil plastic or cross-laminated polyethylene.
3. Overlap seams a minimum of 12 inches using a “reverse shingle” or “upslope lapping” technique (e.g., overlapping so water leaking through the foundation will not flow in between the layers of poly at the seams).
4. Run the barrier up the foundation wall at least 6 inches or attach it to the mudsill if termites are not a problem in the area. Air seal edges to the foundation.
5. Seal seams and around penetrations with adhesive to create an airtight seal. It may be easier to assemble and seal the seams of the barrier outside of the crawl space. When the sealing compound sets up, the barrier should be a continuous sheet.

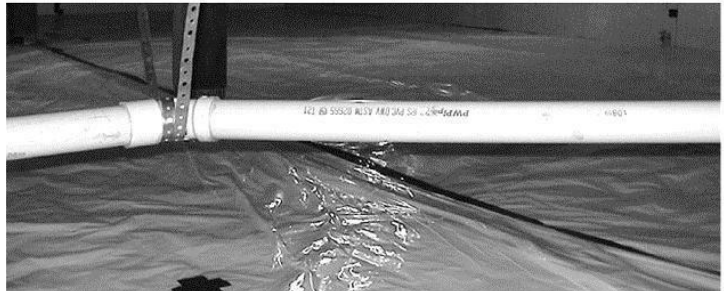

A well-sealed crawl space: The dirt floor in this crawl space is covered with a well-sealed cross-linked polyethylene ground moisture barrier.

Caution: Vapor retarders are typically for use in crawl spaces. Use in basements should be limited to basements with dirt floors and limited access. When the ground vapor retarder is installed in a little-used basement, install walk boards to prevent the customer from slipping. Address any problems, such as plumbing leaks, prior to installing the barrier to prevent water from pooling on top of the barrier.

Open Block Cores

Pollutants and moisture are often found in the bottom of concrete block foundations. When the top of the wall is not sealed or capped, the pollutants and moisture are pulled up into the home due to stack effect and convective looping inside the open cores of the wall. Cap the open cores at the top of the foundation wall using rigid material and air seal around the perimeter of the cap. Treating block cores in this fashion can limit the entrance of moisture and pollutants into the home.

5.5 Lead Paint and Lead-Safe Work

Lead dust can damage the neurological systems of persons who ingest it. Children are more vulnerable than adults because of their rapid brain development and common hand-to-mouth behavior. Lead paint was commonly used in homes built before it was outlawed in 1978. Technicians working on these older homes should either assume the presence of lead paint or, if they believe no lead paint is present, perform tests to rule out its presence.

Lead-safe work practices are used by weatherization professionals when they suspect or confirm the presence of lead paint. Lead-safe work focuses on rigorous dust-prevention and

housekeeping precautions. These practices are required when workers will disturb painted surfaces by cutting, scraping, drilling, or other dust-creating activities. All weatherization field workers must be trained in lead-safe work practices.

Lead Safe Renovator requirements apply in pre-1978 housing when more than 6 square feet of interior painted surface per room or more than 20 square feet of exterior painted surface will be disturbed, or any time windows will be replaced or demolished. See the Wisconsin Weatherization Program Manual for specific policies and guidance regarding Lead Safe Renovator requirements and minimum standards for lead-safe weatherization.

Weatherization activities that could disturb lead paint and create lead dust include, but are not limited to, the following:

1. Removing siding for installing insulation.
2. Drilling holes in the interior or exterior of the home for installing insulation.
3. Removing trim or cutting through walls or ceilings.
4. Weather-stripping, repairing, or replacing doors.
5. Glazing, weather-stripping, or replacing windows.



Wall-blowing tent: This tent protects the customer and their belongings from insulation and paint dust.

When engaging in the above activities, take the following precautions:

1. Tent off the work area by taping a continuous sheet of plastic from floor to ceiling.
2. To protect installers from breathing dust, use appropriate personal protective equipment, such as fit-tested respirators, and coveralls, etc.
3. Confine the work area within the home to the smallest possible floor area. Seal this area off carefully with floor-to-ceiling barriers made of disposable plastic sheeting, sealed at floor and ceiling with zip poles or tape.
4. Cover furniture and carpet in the work area with disposable plastic sheeting.
5. Spray water on the painted surfaces to keep dust out of the air when drilling, cutting, or scraping painted surfaces.
6. Use a dust-containment system with a HEPA vacuum when drilling holes indoors.
7. Clean up as work is performed. Vacuum affected areas with a HEPA vacuum and wet-mop these surfaces daily. Do not use the customer's cleaning tools. Do not leave the customer with lead dust to clean up.



Lead-safe drilling: Using a shrouded drill with a HEPA vacuum removes dust where it is generated.

8. Avoid taking lead dust home by not contaminating clothing, shoes, or tools. Wear boot covers while in the work area and remove them to avoid tracking debris from the work area to other parts of the house. Wear disposable coveralls, or vacuum cloth coveralls with a HEPA vacuum before leaving the work area.
9. Wash hands and face thoroughly before eating, drinking, or quitting for the day.
10. Keep customer and pets away from the work area.

5.6 Asbestos

Airborne asbestos fibers can be dangerous, even when they are not visible to the naked eye. Exposure to asbestos can lead to a host of health problems including, but not limited to:

1. Lung cancer.
2. Mesothelioma, a rare form of cancer found in the thin lining of the lung, chest, abdomen, and heart.
3. Asbestosis, a serious progressive, long-term, non-cancer disease of the lungs.

Disease symptoms may take many years, or decades, to develop after exposure to asbestos. Being a smoker greatly increases the odds exposure to asbestos will lead to disease.

According to Wisconsin Department of Health Services, workers may assume asbestos is not present in wood, metal, glass, and fiberglass. All other building materials should be presumed to contain asbestos, unless proven otherwise through bulk sampling by a certified Asbestos Inspector and analysis by an accredited laboratory. Asbestos that may be mixed in with Vermiculite insulation is the one exception — currently, there is no EPA-approved testing method to demonstrate the presence or absence of asbestos mixed in with vermiculite insulation. Consequently, weatherization workers must always presume that asbestos is mixed in with all vermiculite insulation.

See the Wisconsin Weatherization Program Manual for comprehensive asbestos policies.

5.7 Electrical Safety

Follow these steps for electrical safety in existing homes:

1. Confirm attics contain no exposed wiring. All splices and connections should be in junction boxes.
2. Install covers on open junction boxes in the attic or elsewhere in the building if an imminent hazard exists for the workers or customer.
3. Mark all junction boxes in the attic that will be concealed by insulation using flags.
4. Do not insulate wall cavities containing live knob-and-tube wiring. Eliminate live knob-and-tube wiring.



Knob-and-tube wiring: Prior to insulating around knob-and-tube wiring, barriers must be installed to keep insulation at least 3 inches from the wires.

whenever feasible.

5. If knob-and-tube is not being re-wired as part of the job, isolate live wiring in attics by building a barricade around it. There are several materials that work well as barricades: R-30 unfaced fiberglass batts, concrete-form tube, or other industry-accepted materials. Keep the barricade materials at least 3 inches away from the live knob-and-tube wiring.
6. Inspect wiring, fuses, and circuit breakers to confirm wiring is not overloaded. Install S-type fuses where appropriate to prevent circuit overloading. Maximum fuse or breaker amperage for 14-gauge wire is 15 amps and 20 amps for 12-gauge wire.



S-type fuse: An S-type fuse prohibits the customer from oversizing the fuse and overloading an electrical circuit.

5.8 Combustion Appliance and Fuel Distribution Safety

Determining the safety of combustion appliances and fuel distribution within a dwelling is critical to ensuring occupant safety. Verifying the venting systems for combustion safety are working safely and effectively removing all byproducts of combustion is an essential part of confirming indoor air quality. Fossil fuels can affect indoor air quality and can be an explosive hazard when fuel leaks are present within the dwelling.



Combustible gas detector: These electronic combustible gas detectors are a convenient way to find gas leaks.

5.8.1 Gas Piping Inspection

Natural gas and LPG piping system leaks can be located with an electronic combustible gas detector (CGD), often called a gas sniffer. CGD equipment must:

1. Be classified to UL 913 Intrinsically Safe or equivalent,
2. Have a variable tick rate or changing tone for varying concentration levels,
3. Have a digital display of percentage of Lower Explosive Limit (LEL) and/or provide an alarm when above 10% of LEL, and
4. Have ability to zero ambient conditions.

Safe Environment – Fuel Distribution

Upon entry of a building, the auditor and inspector shall sample ambient air with the CGD in at least one location per floor of occupied space. If any location exceeds 10% of the LEL, the auditor or inspector shall inform the occupants and advise evacuation of the building. Emergency services and/or the gas provider shall be notified from outside of the building.

Upon completion of weatherization on a dwelling, the inspector shall sample ambient air with a CGD in at least one location per floor of occupied space to confirm no gas leaks are present in the home.

Gas Leak Detection

A CGD will find all significant gas leaks, if used properly. Natural gas and LPG fuel distribution

or piping systems may leak at joints and valves. Natural gas is lighter than air and rises from a leak, while LPG is heavier than air and sinks from a leak.

Test for gas leaks by following these steps:

1. Using a CGD, inspect all piping from the meter or tank to all connected appliances checking the entire length of piping, the circumference of all valves and joints at a rate of 1 inch per second. Connections to all gas appliances shall also be inspected. Position the CGD above piping and joints for natural gas and below for LPG gas.
2. If a leak is identified with the CGD, verify the leak with a non-corrosive leak detective solution designed for finding gas leaks. Mark all confirmed leaks with flagging tape or equivalent product.
3. Replace kinked or corroded flexible gas connectors.
4. Repair all verified gas leaks. No gas leaks are allowed in the building or on the customer side of the meter or propane tank at the completion of weatherization work.
5. When CSST is already present in the building and not correctly bonded, bond the gas piping system to the electrical ground in accordance with NEC 250.94 and 250.104 when completing work on the gas piping.

5.8.2 Ambient CO Monitoring

Auditors and inspectors perform ambient CO monitoring during assessments and combustion safety testing to ensure a safe environment.

Ambient CO Monitoring during Building Assessments/Inspections

At all times while assessing the building, auditors and inspectors shall operate a designated ambient CO monitor. CO measurements shall be conducted in all occupied spaces within the building.

If the ambient CO level is **70 ppm or higher**, the auditor or inspector will stop the audit or inspection, notify the occupants of the need to immediately evacuate the building, and leave the building and call emergency services from outside.

If the ambient CO level is in the **range of 36 to 69 ppm**, turn off any appliances that may be producing CO, open the windows and/or doors, and inform the occupants elevated levels of CO were detected.

If the ambient CO level is in the **range of 9 to 35 ppm**, turn off any appliances that may be producing CO, inform the occupants elevated levels of CO were detected, and recommend windows and/or doors be opened.

Ambient CO Monitoring during Appliance Testing

Additionally, ambient CO shall be monitored while performing combustion safety testing as defined in *Chapter 5 – Section 5.8.3* or while testing a gas range and/or oven. If ambient CO

levels exceed 35 ppm, immediately cease testing, turn off the appliance, and open windows and/or doors to dilute levels of CO in ambient air.

5.8.3 Combustion Appliance Safety Inspection

Conduct CO measurements and spillage assessments on natural draft appliances equipped with a barometric damper and all Category I gas appliances connected to a natural draft venting system. CO measurements shall be conducted on gas ovens and direct vent combustion equipment. Depressurization testing is required in all CAZs with permanent natural drafting fuel burning appliances (see *Chapter 5 – Section 5.10*). When appliances are replaced during the weatherization process, testing requirements may change.

Building Setup

1. In preparation for testing, place all combustion equipment inside the Combustion Appliance Zone (CAZ) in standby mode. Turn off any air handlers. Combustion air openings to the outdoors shall be open.
2. Ensure all wood fires are fully extinguished with no hot coals. Shut all fireplace dampers and/or doors.
3. Close all exterior building doors and windows. Close all CAZ doors.
4. Close all interior doors to rooms with NO return air.
5. Leave doors open to rooms with an exhaust fan.
6. Turn off any mechanical ventilation and exhaust equipment.

Greatest Depressurization Achievable

Follow the steps below to place the CAZ under the greatest depressurization achievable (GDA). Subsequent spillage assessments and CO measurements shall be conducted while the CAZ is under the GDA. Run a hose to the outdoors from the reference tap of a digital gauge to measure pressure. If the gauge is not in the CAZ, run hose from the input tap to the CAZ.

1. **Baseline depressurization:** Measure and record the baseline pressure differential or Delta P (ΔP) between the CAZ and the outdoors.
If the baseline measurement seems unreasonable, ensure the pressure hose to the outdoors is not constricted.
2. **Turn on exhaust appliances:** Turn on all exhaust appliances, including any Category III or IV indirect vented gas appliances while excluding whole house ventilation, in the building and record the ΔP between the CAZ and the outdoors.
A pressure differential more negative than the reading from Step 1 usually indicates the exhaust fans have depressurized the CAZ. Pressure effects caused by exhaust appliances will be assessed and corrected when the impact could be harmful to the customer or building.
3. **Turn on the air handler:** Turn on the furnace and/or central air conditioning air handler and record the ΔP between the CAZ and the outdoors. Below are options for turning on

an air handler.

- a. At the thermostat, use the Fan On option to start the air handler.
- b. Start the forced air furnace and let it operate until the air handler starts.
- c. Use a jumper from the R and G thermostat leads to create the Fan On circuit.
 - i. When the forced air furnace is commonly vented with another appliance, this step may be skipped if a fan only option is not available and tester is not comfortable with R to G jumper.

If the ΔP has become more negative than in Step 2, it usually means leaky return ducts in the CAZ or supply leaks in an attic have depressurized the CAZ. In contrast, a more positive ΔP usually means leaking supply ducts in the CAZ or return leaks in an attic have pressurized the CAZ. If the CAZ is pressurized by the air handler, turn it off before continuing to Step 4.

4. **Open the door to the CAZ:** Open the door to the CAZ and record the ΔP between the CAZ and the outdoors.

If the pressure difference is more negative than in Step 3, leave the CAZ door open. It may mean the exhaust fans are depressurizing the CAZ. If the pressure difference is more positive, close the CAZ door.

Spillage Assessment and CO Measurement

Identify the conditions under which the greatest depressurization was achieved and set up the building to match. For example, exhaust fans on, air handler on and CAZ door open. NOTE: If you started the air handler by operating the furnace, you may not be able to test a water heater connected to a shared natural venting system with the air handler running without the furnace operating.

For domestic water heaters or appliances connected to a **warm venting system**, spillage shall be assessed at 2 minutes of main burner operation. CO measurement of undiluted flue gas shall be taken at 5 minutes of main burner operation. Compare CO measurements to acceptable CO limits (see *Table 5-2*) and take corrective actions as needed.

NOTE: If you ran the furnace in Step 3 to start the air handler and if connected to a natural drafting venting system, it will be warm.

For appliances connected to a **cold venting system**, spillage and CO measurements shall be assessed at 5 minutes of main burner operation. Compare CO measurements to acceptable CO limits (see *Table 5-2*) and take corrective actions as needed.

For combustion appliances **sharing a chimney and/or venting system**, testing is completed in order from lowest BTU/hr input rating to highest BTU/hr input rating. Complete testing of the smallest BTU/hr appliance following the procedure for a cold or warm venting system as appropriate to the system's condition. After completion of spillage and CO measurements, place

the next largest BTU/hr combustion appliance in operation while the first appliance is still firing. After 2 minutes of operation, test for spillage on the first appliance and then immediately after check spillage for the second appliance. Measure CO of the second appliance after 5 minutes of operation. Compare the CO measurements to acceptable CO limits (see *Table 5-2*) and take corrective actions as needed.

For **direct and power vent appliances**, CO Measurement of undiluted flue gas shall be taken at 5 minutes of main burner operation. Compare the CO measurements to acceptable CO limits (see *Table 5-2*) and take corrective actions as needed.

Spillage Corrective Actions

When spillage is identified, corrective actions are recommended based on conditions causing the GDA. To verify spillage is not caused by a non-code compliant venting system, check for spillage under baseline conditions.

- If spillage occurs under baseline/natural conditions, correct the venting system to make it code compliant.
- If GDA is caused by the air handler operation, evaluate the forced air distribution system and complete duct sealing as needed. If GDA occurs with CAZ door closed, evaluate the forced air distribution system, and increase the amount of return air, if possible.
- If GDA is caused by high exhaust flow rates, consider reducing exhaust flow rates or installing make-up air. If neither option is acceptable, consider replacement of the appliance with spillage.

CO Corrective Actions

If measured CO exceeds the thresholds outlined in the acceptable CO limits (see *Table 5-2*), service the appliance to reduce production of CO or consider replacement of the appliance.

Table 5-2 Acceptable CO Limits

CO Thresholds for Fuel Fired Combustion Appliances	
Appliance	Threshold Limit
Central Furnace (all categories)	400 ppm air free
Boiler	400 ppm air free
Floor Furnace	400 ppm air free
Gravity Furnace	400 ppm air free
Wall Furnace (BIV)	200 ppm air free
Wall Furnace (Direct Vent)	400 ppm air free
Room Heater*	200 ppm air free
Water Heater	200 ppm air free

CO Thresholds for Fuel Fired Combustion Appliances	
Appliance	Threshold Limit
Clothes Dryer	400 ppm air free
Gas Log Fireplace	25 ppm as measured in vent
Gas Log (in wood fireplace)	400 ppm air free in firebox
Gas Oven/Broiler	225 ppm as measured

**Unvented heaters may not remain in completed weatherized buildings.*

Range-Top Burners

Inspect range-top burners prior to testing ovens for carbon monoxide levels. Dirty or misaligned range-top burners may cause generation of excessive CO. Damaged burners or stove grates, or foil burner liners that interfere with the flame pattern, may cause the burner to create a yellow or orange flame. In this condition, the burner is likely generating high volumes of carbon monoxide. If any of these conditions are observed, advise the occupants the range should be cleaned or repaired by a qualified professional to reduce the generation of CO.

Testing Gas Ovens

While the oven is turned off, complete a visual inspection.

1. Check for air blockage at the bottom of the oven and/or drawer and remove any obstructions.
2. Remove any items stored in the oven and any foil coverings that may be obstruction air venting.
3. Inspect the oven for cleanliness. Testing can be affected by a dirty oven. Advise occupants to clean oven to reduce generation of CO.

Turn the oven on to a temperature of 500°F. Do NOT turn up to the highest setting, broil setting or self-cleaning setting. After 5 minutes of operation, insert the testing probe into the throat of the oven exhaust vent and measure undiluted CO. Record stabilized “as measured” level of CO. Advise occupant/owner to have oven serviced by a qualified professional if measurement is higher than 225 ppm as measured.

5.9 Measuring Natural Draft

Measuring draft for gas appliances is not required but can be a useful test to confirm spillage or to assess the strength of the venting system. Draft is measured in inches of water column (IWC) or pascals (Pa). Measuring over fire draft is required for oil appliances and should not exceed the manufacturer's specifications (usually .02 IWC or 5 Pa). Excessive overfire draft can be reduced by adjusting the barometric damper.

Natural draft is produced by the difference in the weight of a column of flue gases within a chimney or vent and a corresponding column of air of equal dimension outside the chimney or vent. A negative pressure in the chimney or vent with respect to indoors is created by natural draft. The strength of this draft (weight difference) is determined by the venting height, its cross-sectional area, and the temperature difference between the column of flue gases and the column of air. Measured natural draft in a venting system should always be negative with respect to indoors. A positive reading indicates the flue gases are spilling into the **combustion appliance zone (CAZ)**. A CAZ is any location in a building where combustion appliances are located, most often the basement in Wisconsin.

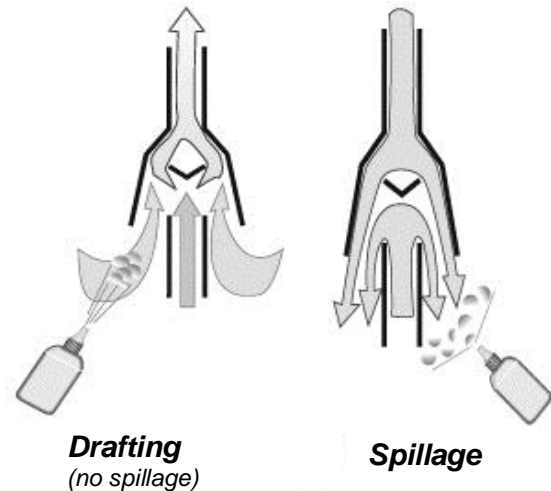

Spillage: A smoke tester helps determine if spillage is occurring during appliance operation.

Venting systems transport combustion gases using the flame's heat and the gases' buoyancy. Natural draft and fan-assisted gas appliances are designed to operate at a natural draft of around negative 0.02 IWC, or - 5 pascals. Tall venting systems located indoors typically produce stronger drafts, and short or outdoor venting systems produce weaker drafts. Wind and house pressures can have a big impact on natural draft in venting systems. Depressurization can cause spillage of combustion gases into the CAZ.

Natural draft appliances connected to chimneys or vents require a draft diverter to dilute the flue gases and limit the chimney temperature, keep the draft from getting too strong, and keep wind gusts from interfering with the appliance's burner.

Fan-assisted appliances employ a small fan near the exhaust of their heat exchanger. This fan draws the products of combustion through the heat exchanger, but it has little or no effect on the draft up the chimneys. A poorly functioning natural draft chimney may allow combustion gases to leak into the CAZ.

Higher efficiency appliances, including sealed combustion heating systems and power-vent water heaters, employ mechanical draft. This mechanical draft is produced by a fan. When the fan is located to push the flue gases through the venting system, the draft is forced. When the fan is located to pull the flue gases through the venting system, the draft is induced. A positive pressure in the venting system with respect to indoors is created by mechanical draft after the

fan. The venting system must be airtight after the fan otherwise the positive pressure inside the venting system will force combustion gases into the CAZ. The mechanical draft created is strong enough to resist the influence of most indoor and outdoor pressures.

Before testing, inspect the combustion venting system for damage, leaks, disconnections, inadequate slope, and other safety hazards.

5.10 Depressurization Guidance

Subtract the baseline reading from the largest negative reading (or the smallest positive) if baseline was manually measured and recorded, to get the greatest depressurization achievable (GDA). If the automatic baseline feature was used, record the largest negative reading (or the smallest positive). Compare the GDA value to those in Table 5.5. If the GDA is greater than the listed maximum value, the possibility of spillage occurring is more likely. For wood fired appliances or fireplaces, consider make-up or dedicated combustion air when GDA exceeds -5 Pa.

Table 5-5: Depressurization Guidelines for Combustion Appliance Zones

Appliances and Venting Systems	Maximum Depressurization (pascals)
Orphaned Natural Draft Water Heater (oversized venting system). <i>Note: chimney lined with clay or other liner but still oversized</i>	-2
Natural Draft Water Heater and Natural Draft Heating System with common venting	-3
Stand Alone Natural Draft Water Heater (properly sized venting system)	-5
Natural Draft Heating System or Stove (including wood burning systems)	-5
Natural Draft Water Heater and Fan Assisted Heating System (fan inside furnace cabinet) with common venting	-5
Natural Draft Water Heater and Induced Draft Heating System (fan at point of exit at wall) with common venting	-5
Induced Draft Heating System (fan at point of exit at wall)	-15
Power Vented Water Heater and Sealed-Combustion Heating System	-25
The Maximum Depressurization Guideline (MDG) is the most restrictive MDG in the Combustion Appliance Zone (CAZ).	

5.10.1 Make-Up Air Systems

Make-up air may be an option when the combustion appliance zone is excessively pressurized or depressurized and the appliance does not pass worst-case draft. Use guidelines listed in *Table 5-5 Depressurization Guidelines* to determine acceptable pressures.

Add make-up air equal to 40 percent of the total exhaust ventilation. Multiply the total exhaust CFM (both continuous and intermittent) by 40 percent (0.40) to determine the amount of make-

up air required (CFMs).

Make-up air systems provide supply air by way of fans and/or ductwork that introduce outdoor air into the home. These systems are sometimes electrically interlocked with exhaust fans elsewhere in the home so both fans run at the same time. This protects against the depressurization caused by large exhaust-only fans such as oversize range hoods. Balancing of the two air flows can be performed by balancing dampers in the fresh air duct. These systems, if properly balanced, can create house pressures closer to neutral than exhaust-only or supply-only systems. Follow the manufacturer's requirements for mixed air temperature and the location of the fresh air inlet if connecting the make-up air duct to the return side of a forced air furnace.

When make-up air is installed, label the intake fitting “ventilation air intake” and educate the customer to keep yard debris and other contaminants clear of the intake.

5.11 Water Heater Replacement

Occasionally, water heaters must be replaced for health and safety reasons. For information on replacement installation procedures, refer to *Water Heater Replacement in Chapter 4 – Section 4.1*. These reasons may include, but are not limited to:

1. Water heater is backdrafting/spilling. Refer to *Improving Inadequate Draft in Chapter 3 – Section 3.14.1* for guidance on how to remedy these problems.
2. The shell of the storage tank actively leaks and cannot be repaired.
3. Severe flame rollout that cannot be repaired.
4. Carbon monoxide measurement above 200 ppm air-free that cannot be repaired.

5.12 Mechanical Ventilation

Ventilation is an important health and safety consideration in homes weatherized in Wisconsin. Many homes have blower door-measured airtightness and building characteristics that necessitate mechanical ventilation as a means of keeping indoor air quality at a safe level.

The customer may refuse the installation of ventilation in their home. Any customer refusing the installation of ventilation must sign the *Refusal of Ventilation: Release of Liability, Indemnification and Waiver of Claims*, available via the link at the beginning of *Chapter 5*. Refusal of ventilation does not constitute refusal of a major measure but will not be an eligible DOE job. An original copy of the waiver must be given to the customer and a copy retained in the customer's file.

5.12.1 Choosing Ventilation Systems

Ventilation systems must be matched to the home. A home may require only simple exhaust fans in bathrooms and/or the kitchen to provide adequate ventilation. Very tight homes may require a balanced centrally ducted ventilation system.

When ducted ventilation systems are installed in homes with forced-air heating or cooling systems, the ductwork can be shared in a simplified or ducted exhaust installation. Though these hybrid approaches can save some of the initial cost, these systems are more complicated, require an interlock with the furnace fan, and are prone to pressure imbalances. Install fully ducted systems whenever possible.

In cold climates, heat-recovery ventilators (HRVs) or energy-recovery ventilators (ERVs) can offset some of the heat loss from exhausted air. The heat-recovery savings will be greatest when winter temperatures are the lowest.

5.12.2 Sizing Ventilation Systems

Whole-building ventilation systems are sized according to the size of the home and the number of occupants as described by the ASHRAE 62.2 standard. Use the Diagnostic Workbook to determine if whole-building ventilation is required. Note: Existing ventilation may be modified to provide either continuous or intermittent ventilation at the required amount, based on the integrity of the existing installation.

5.12.3 Local Exhaust Fans

The ASHRAE 62.2 standard for acceptable indoor air quality establishes an on-demand or an optional continuous flow rate for local exhaust in bathrooms and kitchens. An alternate compliance path that increases the flow rate of whole-building ventilation to offset the lack of local exhaust is available for existing homes.

Follow these instructions when installing local exhaust fans to remove bulk pollutants and moisture:

1. Locate exhaust fans as close to the source(s) of pollutants/moisture as possible. For example, install bath fans in the shower or as close as practical, and install kitchen fans near the range.
2. Install exhaust fans as close as possible to the heated space, which usually means against the ceiling surface.
3. Consider the positioning of the new fan's exhaust port. Position ceiling fans so the exhaust port runs parallel with the ceiling joists and points toward the existing exhaust termination. If no existing termination is present, best practice is usually to point the fan's exhaust port toward the center of the attic. This makes it easier to attach exhaust ducting.
4. Avoid installing fans in vaulted ceilings, walls, or slopes if possible. These installations displace insulation and make it difficult to avoid cold spots, which foster condensation. In addition, these installations make it difficult to duct the fan to the outdoors.

5.12.4 Whole-Building Exhaust-Only Ventilation

The ASHRAE 62.2 standard for acceptable indoor air quality establishes a rate for whole-building ventilation based on floor area and the number of occupants. When natural ventilation does not fulfill the entire established rate for whole-building ventilation, mechanical ventilation is installed. In Wisconsin, the most common approach is exhaust-only ventilation. Local exhaust requirements may also be met by increasing the flow rate of installed whole-building ventilation.



Surface-mounted exhaust fan: Exhaust fans aid air quality by drawing fresh air into the building as they remove indoor pollutants.

Follow these instructions for the installation of whole-building exhaust ventilation:

1. Install fans in bathrooms or kitchen when practical to reduce overall flow rate when following alternate compliance for local exhaust requirements.
2. In-line exhaust fans may be installed in a remote location such as the attic or basement. Ducting can be installed to one or two intake locations and then terminated to the outdoors. One option is to use the existing ceiling exhaust as an intake location after removing the fan assembly from the housing. This option avoids cutting new holes in ceilings.
3. Install fans with built-in controls or install a separate control to allow for the adjusting of the flow rate and frequency-of-operation as needed. Label all controls.
4. Install a service or shut-off switch if not an integral part of the fan control. Label all controls.
5. Measure the flow rate of the installed exhaust ventilation and record on Diagnostic Workbook. Record the highest flow rate in the exhaust fan section. Record the continuous or intermittent rate in the ventilation section.
6. Adjust the controls to provide the required flow rate at a continuous rate. Adjust controls for frequency-of-operation when operating intermittently. Intermittent operation should occur at least once in every three-hour time period.
7. Calculate intermittent operation using this formula: $\text{required flow} / \text{rate measured flow rate} \times 60$. The result is the number of minutes per hour the ventilation should operate. The Diagnostic Workbook will assist installers in setting operational controls.

5.12.5 Exhaust Fan Ducting

Discharge exhaust fan ducting to the outdoors and not to an attic, crawl space, or garage, where moisture and pollutants can accumulate. Duct exhaust fans to the outdoors as follows:

1. Use flexible or rigid ducting material.
2. Ensure a backdraft damper is present. The damper may be part of the termination hood, it may be integrated into the fan unit, or it may be installed separately in the exhaust duct.

3. Where practical, begin the ducting run by connecting a one- to two-foot section of straight rigid duct to the fan's exhaust port, to improve air flow.
4. Avoid installing elbows at 90-degree angles — this can reduce air flow. Instead, install elbows at as gradual and smooth of an angle as is reasonable.
5. Make duct runs as short as is practical. Avoid long duct runs, especially where they are above the insulation or running horizontally.
6. Attach the ducting material to the fan's exhaust port and to the termination hood.
7. Seal all joints in the exhaust-ducting run including at the fan and termination.
8. Insulate the ducting to a minimum of R-8 in unheated spaces. Ensure the insulation is secure and provides continuous coverage.
9. In multi-family housing, for continuous ventilation, multiple exhaust fans may be combined into a "collector box" and exhausted with an appropriately sized termination hood. In these cases, ensure there is a backdraft damper integrated into every fan unit.
10. Use a termination fitting with an integrated collar. The termination shall have a screen material installed so it does not inhibit damper operation or restrict air flow.
11. Install termination hoods to the outdoors and not to a buffer zone, such as an attic, crawl space, or garage, where moisture and pollutants can collect.
12. A termination shall be installed a minimum of 3 feet away from any property line, a minimum of 3 feet away from operable openings to houses, a minimum of 10 feet away from mechanical intakes, or as required by authority having jurisdiction.
13. Install the top half of roof caps underneath the shingles, in order to prevent rainwater from leaking into the attic. Use galvanized or stainless-steel fasteners and use roofing cement to seal any leakage points.
14. Galvanized steel, stainless steel, or copper shall be used for termination fitting for kitchen exhaust fans.

5.12.6 Supply Ventilation Systems

Supply ventilation systems introduce fresh air into the home and do not include heat recovery. They are usually installed in conjunction with forced-air heating or cooling systems. They incur an energy penalty as unconditioned air is brought into the home. It is critical with this, and any other installation utilizing the forced-air system, to follow the manufacturer's requirements for mixed air temperature and the location of the fresh air connection. Introducing very cold outdoor air directly into a forced-air furnace creates a risk of cracking the heat exchanger and will void the heating system warranty. The temperature of the air into the return side of the furnace cabinet should never be below 60°F for systems with continuous outdoor air supply or 55°F with an intermittent air system. Also, since this modification could result in cooler supply register air temperatures, the customer must understand and agree to this installation. Simple supply systems are difficult to balance effectively, especially in well-sealed homes. Central balanced ventilation systems are often a better choice considering overall efficiency and the need to balance house pressures.

The most common type of supply-only ventilation includes an outdoor air duct connected to the main return of a central forced-air heating or cooling system. The HVAC system's fan draws outdoor air into the plenum, delivering ventilation air to the home along with heated or cooled air. No ventilation air is supplied unless heating or cooling is needed.

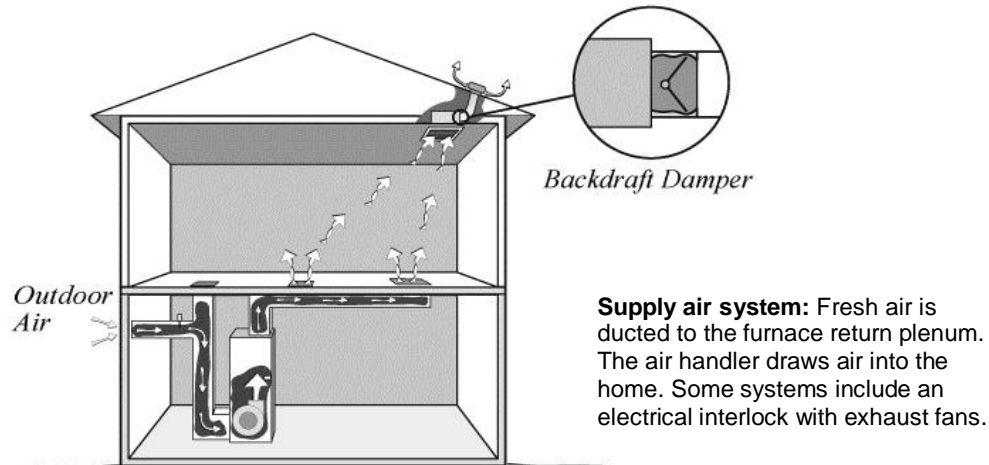

The fresh air duct should have a balancing damper installed so the air flow can be adjusted during the initial installation. A motorized damper is sometimes installed to close the outdoor air duct when ventilation air is not needed.

Supply ventilation systems pressurize the home, forcing indoor air out through openings in the shell. This may keep outdoor pollutants, such as carbon monoxide from vehicles and lawn chemicals, out of the home as long as the fresh air intake draws air from a clean location.

The positive house pressure created by supply ventilation systems can force indoor moisture into the walls. This can promote condensation in building cavities during cold weather. Moderate levels of pressurization are not usually a concern, though, if indoor RH is kept at or below 35 percent.

Supply systems introducing air to the HVAC system can be configured to provide fresh air when neither heating nor cooling systems are operating. In this mode, the HVAC fan can be set up to circulate ventilation air only. This method is most efficient when a variable-speed HVAC fan allows the slower air flow required for ventilation-only operation. Single-speed HVAC fans move too much air and consume too much electrical power for efficient continuous operation.

5.12.7 Balanced Ventilation Systems

Balanced ventilation systems provide measured fresh air via planned pathways. Of all the ventilation schemes, these systems can do the best job of controlling pollutants in the home when properly installed. Balanced systems move equal amounts of air into and out of the home. Most balanced systems incorporate heat-recovery ventilators that reclaim some of the heat and/or moisture from the exhaust air stream. Simple mixing boxes are occasionally used to temper incoming air by mixing it with exhaust air, but their cost approaches that of heat-recovery

ventilators, and they incur an energy penalty as conditioned air is lost to the outdoors.

When operating properly, balanced systems reduce many of the safety problems and moisture-induced building damage possible with unbalanced ventilation. Balanced systems are not trouble-free, however. Proper design, installation, and maintenance are required for effective operation.

These complicated systems can improve the safety and comfort of the home, but they require regular customer maintenance and periodic service (preferably by a knowledgeable professional) to ensure they operate properly. Testing and commissioning are vital during both the initial installation and periodic service calls.

Variation 1: Fully Ducted and Balanced Systems

The most effective central ventilation systems include dedicated ductwork for both supply and exhaust air. All the system ducting leads to a central ventilator, which includes an HRV core to reclaim heat.

Fully ducted systems are installed independently of other forced-air ducting. This gives the designer a high level of control over air flow and house pressure. They are most easily installed in new construction and are more difficult to install during weatherization.

High-quality ductwork is a critical component of successful ventilation systems. Ducts should be sized large enough to minimize static pressure and reduce noise, and hard metal ducting should be used wherever possible. All seams and joints should be sealed using mastic or metallic tapes or other UL181 approved material. Exhaust grilles should be installed near the sources of contaminants in bathrooms, kitchens, or other areas where other pollutant-producing activities take place.

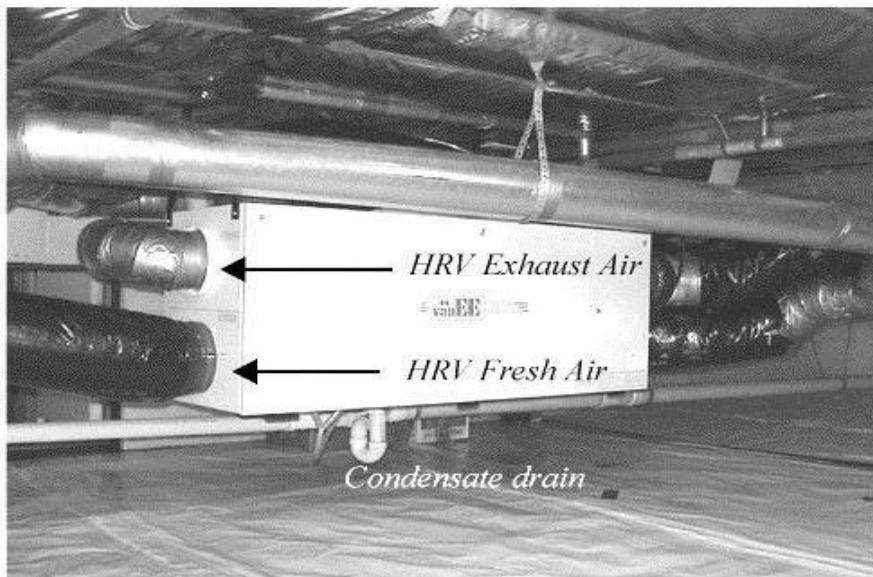

Fully ducted heat-recovery ventilator: Matched exhaust and supply fans provide balanced air flow. Dedicated exhaust ducting collects pollutants from bathrooms and kitchen. Supply ducting carries fresh air to bedrooms and central living areas. A heat-recovery core reduces energy loss from exhausted air.

Variation 2: Ducted-Exhaust Balanced Systems

Ducted-exhaust systems are connected to central forced-air systems. Dedicated ducting collects pollutants from bathrooms and kitchens. The exhaust air passes through a central HRV core before being exhausted to the outdoors. Fresh air is brought in through the HRV core, collects the heat extracted from the exhausted air, and is introduced to the forced-air system at either the supply or return plenum. Always follow the manufacturer's instructions for mixed air temperature, the location of the fresh air insert, and minimum return air temperature.

The air flow should be balanced in ducted-exhaust systems so house pressures remain close to neutral. In practice, this is harder to achieve than in fully ducted systems because of the influence of the forced-air blower. With typical air flows of 50-200 CFM, central ventilators are easily overwhelmed by the 500-1500 CFM air flows of forced-air systems. A high level of care is needed during design, installation, and commissioning of ducted-exhaust ventilation systems to achieve proper air flows and to achieve reliably balanced house pressures.

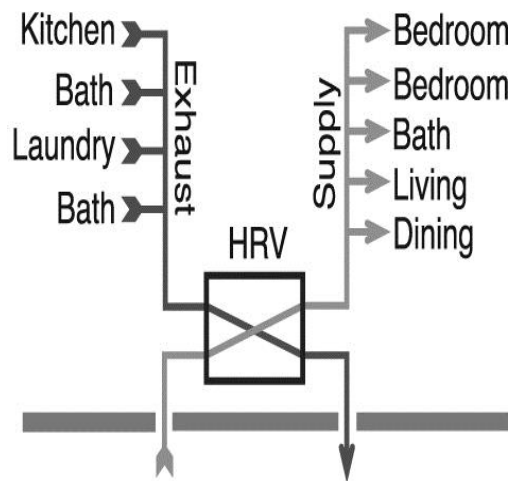

Fully ducted central ventilator: Fully ducted systems do the best job of collecting pollutants. Installed independently of heating and cooling systems, fully ducted systems work well in homes with hydronic or electric baseboard heat where no ducting is installed.

Variation 3: Simplified Balanced Systems

Simplified, or volume ventilation, systems are connected to central forced-air heating or cooling systems. This is the least-favored ducting option.

Simplified systems draw exhaust air from the forced-air return air plenum. This air passes through the central ventilator that includes an HRV. Most of the exhaust airstream's heat is transferred to supply airstream, and fresh air is re-introduced to the forced-air return ducting. Always follow the manufacturer's recommendation for interlocking the air handler with the fresh air inlet. This system requires regular, effective customer maintenance, as system failure will result if maintenance requirements are not followed.



Polyethylene HRV core: This flat-plate counter flow heat exchanger slides out for cleaning.

5.12.8 Heat-Recovery Ventilators

Heat-recovery ventilators (HRVs) are often installed in conjunction with balanced whole-house ventilation systems. The HRV core is usually a flat-plate aluminum or polyethylene air-to-air heat exchanger in which the supply and exhaust airstreams pass one another and exchange heat through the flat plates.

5.12.9 Heat-Recovery Ventilator (HRV) and Energy-Recovery Ventilator (ERV) Installation

Follow the specifications below when installing a balanced ventilation system:

1. Install the system following the manufacturer specifications.
2. Install a backdraft damper between the heat-recovery ventilator (HRV) or energy-recovery ventilator (ERV) and the exterior.
3. Insulate ducts installed outside of the thermal envelope to a minimum of R-8.
4. Seal the gap between registers or grilles and interior surface.
5. When connected to the heating system, exhaust air shall not draw directly from the heating system. Supply ducts should be installed as close to the HVAC system's fan as possible.
6. Educate the customer about how and when to change filter and clean the drain pan, according to manufacturer specifications.

5.12.10 Ventilation Control Strategies

Controls provide an opportunity for fine-tuning ventilation systems. Controls let the installer and customer choose when the system runs and how much air it moves.

Controls also provide an opportunity to adjust the system performance over time. The customer should be advised a periodic review of the control scheme should be performed, perhaps during service visits, to ensure the system is providing sufficient fresh air for customer and acceptable moisture control for the building.

Locate the controls in a representative location on a main floor interior wall, and about 48 to 60 inches above the floor. Do not install them on an exterior wall, in a drafty location, or in direct sunlight.

Manual Control

Simple on/off manual controls allow the customer to ventilate as needed. These are often used for exhaust fans in bathrooms and kitchens. Their effectiveness relies on a customer's perception of air quality.

Manual controls sometimes include countdown or time-delay timers activated by customer and run for a specific period of time. In non-owner-occupied homes or other situations where a customer understands and cooperation is unlikely, fan-delay timers can be run in conjunction with bathroom lights to give a set period of ventilation whenever the bathroom lights are used.

Humidity Control

De-humidistats operate equipment based upon indoor humidity levels. They are used with either simple exhaust fans or central ventilation equipment. De-humidistats can be set for a range of humidity levels and have the advantage of automatic operation that does not require much customer management. They should be set to keep indoor humidity low enough to prevent indoor condensation in the winter. This will vary from 30–50% RH, depending upon the outdoor temperature, effectiveness of windows and insulation, and other factors.

Combination Controls

Central ventilation systems are often operated by a combination of manual and automatic controls. The most common strategy utilizes a multi-speed fan that runs on low or medium speed to provide continuous ventilation. Override switches in the kitchen and bathrooms activate high-speed operation to provide intermittent high-speed operation during polluting activities such as cooking, bathing, or cleaning. The total air flow requirement specified by ventilation standards refers to this high-speed operation.

Timers allow the low-speed operation to be set for variable intervals such as 20 minutes on/40 minutes off per hour, 30 minutes on/30 minutes off, or whatever total ventilation time is needed. This adjustable interval provides an effective method of matching the ventilation capacity to the customer's needs.

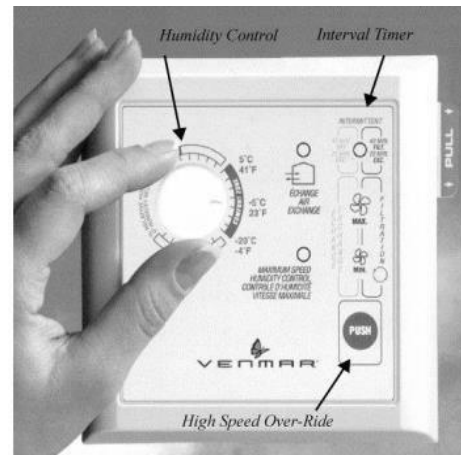

Central combustion control: The system can be controlled by humidity, time interval, or manually.

5.13 Dryer Venting

Clothes dryers produce moisture and combustion gases (if gas-fired). These issues become an indoor air quality hazard in homes if not properly vented to the exterior.

Educate the customer about proper maintenance for the dryer vent and termination. The customer should clean the exterior vent termination frequently. Once or twice each year, the customer should clean the rest of the dryer venting system including the venting run ducting and the connection between the dryer and the ducting.

Consider the following when there is existing dryer venting:

1. If the existing is metal-flex duct and UL listed, the ducting may be left in place if deemed in good condition with no blockage. Shorten or re-route existing metal ducting if needed. Seal all seams and connections with tape or mastic, keeping in mind it may need to be removed for maintenance.
2. If the existing is vinyl duct, re-vent the dryer to the exterior with UL-2158A approved 28-

gauge metal ducting with a smooth interior.

3. If the vent termination is damaged, replace with a new termination.

Follow these instructions when installing new dryer venting:

1. Follow the most direct route to the exterior when installing dryer duct, as feasible.
2. Use UL-listed materials for ducting. Best practice is to use rigid metal duct with a smooth interior surface which provides less resistance to air flow.
3. Install a dedicated termination with backdraft damper/flapper. Best practice is to install a louvered (three- or four-flapper) hood, as these hoods typically have the strongest air flow and work the best to prevent pest intrusion. Termination may not contain a pest screen.
4. Vent all unvented dryers to the exterior. Do not vent dryers into attached garages, under porches, under decks, or where the moisture will damage building components.
5. Seal all seams and connections with tape or mastic, must be 181B or 181B-M listed material, keeping in mind it may need to be removed for maintenance.
6. Use a hose clamp to fasten the duct to the dryer's exhaust port. Do not use screws to make this connection. The screw tips will catch dryer lint, creating an obstruction and a fire hazard inside the ducting.
7. Insulate, to a minimum of R-8, sections of the dryer duct that run through unconditioned space. Exception: Under mobile homes, ensure a downward pitch so moisture may drain outwards.

5.14 Priorities for Existing Homes

There are some advantages to designing ventilation systems for existing homes. First, the home provides an observable history from which to work. Stained ceilings, peeling paint, and mildewed attic framing all tell the story of how a building operates. The customer may identify problems not immediately apparent, such as periodic back drafting of combustion appliances. In addition, the existing home has already aged, allowing lumber to dry and modern materials to out-gas, reducing the pollutant load on the ventilation system.

First, identify any major sources of moisture and other pollutants, and remove them or seal them away from the house. No ventilation system can effectively handle excess amounts of any pollutants.

Complete shell measures to ensure reliable pressure and thermal boundaries. The heating, cooling, and ventilation systems depend on these measures to operate effectively.

The choice of ventilation equipment will depend upon the building's structure, airtightness, customer understanding and commitment to maintenance, and mechanical systems. Many homes may require only exhaust fans. A blower door test and an assessment of the home's existing ventilation will provide the information to determine the home's ventilation needs.

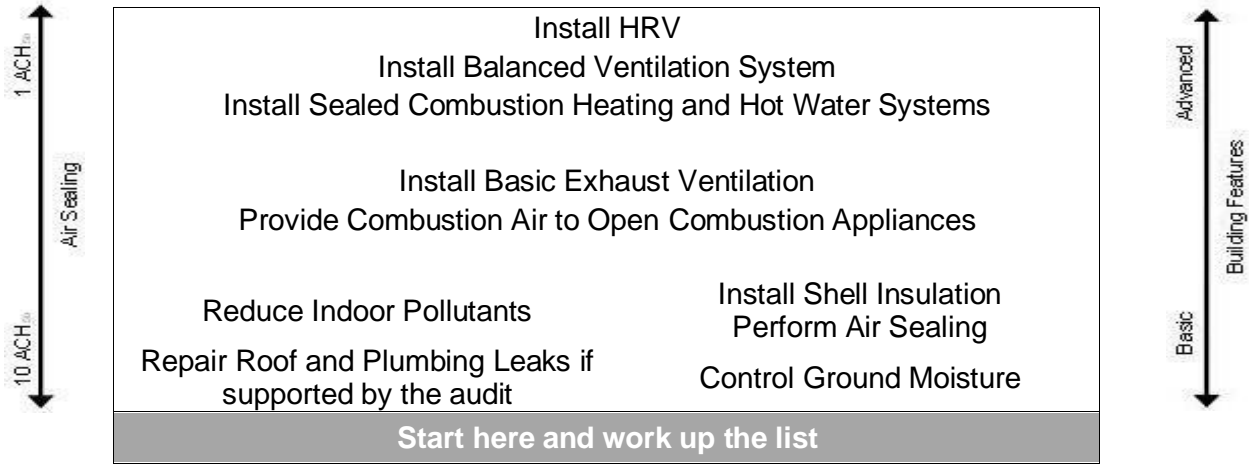

Hierarchy of housing needs: Keep the entire structure in mind as you design and install mechanical systems.

5.14.1 Installation Best Practices

A high level of quality control is needed to ensure ventilation systems work as intended. Properly designed and installed systems help create a healthy indoor environment and a long-lived building, while poorly executed systems can be ineffective or dangerous. Complex central heat-recovery ventilation systems require the most attention to design and installation.

5.15 Radon

Radon is a naturally occurring odorless and colorless gas found in soil and rock. This radioactive gas is formed during the decay of uranium-238 with higher levels found in some areas of the United States. Where present, radon may seep from the ground through openings in foundations and slabs and enter homes. Exposure to radon has been shown to cause health issues for occupants in homes.

5.15.1 Sumps

Some homes have sumps to collect water that infiltrates the basements or crawlspaces. The dictionary definition of a sump is “a pit or reservoir serving as a drain or receptacle for liquids” (<https://www.merriam-webster.com/dictionary/sump>). In residential buildings sumps can be pre-formed plastic crocks, pre-formed concrete basins, ceramic crocks, plastic buckets, or even holes in a slab or in the dirt floor of a crawlspace. Most commonly, preformed sump crocks are connected to the ground, and often to drain tile water management systems under the slab.ⁱ

Any sump that is connected to the ground must be sealed (*ASTM:7.3.6.1; AARST:8.5.1*).ⁱ If a sump is directly connected to the ground such as a hole in the floor of the slab or dirt floor, or if drain tile is connected to the sump, the opening shall be covered with a cover and sealed (SWS 2.0401.2) when applicable (WPN 22-7). When sumps are installed to allow for bulk moisture to

drain, a one-way ball valve fitting should be installed if there is enough room (SWS 2.0401.2). Sump covers are required when applicable to help reduce the possibility of radon from entering the home. Covers shall be sealed with silicone caulk or other material that will allow for an air-tight seal, along with any penetrations through the cover. If there is a pump present, it shall be turned off and unplugged prior to any work commencing.

In the event that a sump pump cover is refused or cannot be installed, ASHRAE 62.2 ventilation may be installed in the lowest level of the home to reduce the ambient level of radon.

5.15.2 Sump Pumps

Sump pumps come in two styles, either submersible or pedestal pumps. Submersible pumps sit totally submerged in the sump crock. Pedestal pumps have the pump motor extended above the sump crock. In principle, both types of sump pumps operate the same. As the water rises in the sump crock, a float attached to the pump rises until it triggers the pump to turn on and pump water out of the crock. Submersible pumps can have floats that are free floating or that ride up and down on a shaft. The float on a pedestal pump rides on a rigid shaft that extends above the plane of the sump crock.ⁱ



Submersible pump
(free-floating float)



Submersible pump
(shaft float)



Pedestal pump

Photos courtesy of Dick Kombluth, LLC

5.15.3 Sump covers for submersible pumps

1. For flat covers, sump pit cover materials must be rigid and made of polycarbonate plastic or other rot resistant material such as pressure treated plywood (*ASTM:7.4.7; AARST:8.5.1*).
2. The covers shall be secured with silicone caulk or if gasketing material is used mechanical fasteners are required such that the cover can be removed. (*ASTM:7.4.7; AARST: 8.2.5*).
3. All sump cover penetrations shall be sealed. (*ASTM: 7.4.8; AARST: 8.5.1*).ⁱ

Sump crock – clear cover-sealed



Sump hole – clear cover-sealed



Photos courtesy of Dick Kombluth, LLC

5.15.4 Sump covers for pedestal pumps

There is no way to take the pump apart so holes can be drilled in the cover for the pedestal and rigid tubing that the float is attached to. The tubing would not be able to be sealed since it moves when the float moves. The only options for sealing a sump with a pedestal pump are to.

1. Replace the pedestal pump with a submersible pump and then seal the sump.
2. Install a commercially made cover for the pedestal pump.ⁱ



Pedestal pump



High rise sump cover

Photos courtesy of Dick Kombluth, LLC

5.15.5 Floor Drains

Floor drains are often connected directly to the ground under a slab and not to any waste plumbing. Installing a one-way drain may help reduce the possibility of radon entering the home.

1. Determine if the floor drain is connected to the ground under the slab or to waste plumbing.
2. If the drain is connected to the ground, follow the manufacturer's instructions for installing the appropriate one-way drain.ⁱ



Dranjer® one-way drain (FR2)

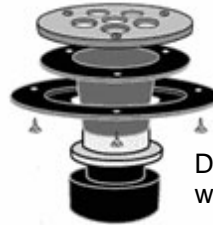

Dranjer® one-way drain (FS2)

Photos courtesy of Dick Kornbluth, LLC

Final Inspection and Quality Assurance Standards

Acceptable installation shall meet the following standards:

1. All Health and Safety measures were completed when appropriate to eliminate or reduce existing hazards or to eliminate or reduce hazards created as a result of the installation of weatherization materials.
2. All appliances passed spillage testing where required and measured CO levels are within standards.
3. No gas leaks are present in building and/or LEL readings are at 0.
4. Ambient CO levels do not exceed 9 ppm.
5. CO alarms are installed where required.
6. Smoke alarms are installed where required.

Ventilation for Indoor Air Quality

1. Whole-building ventilation and local exhaust were installed as required.
2. Measured flow rate of whole-building mechanical ventilation is between 90% and 150% of the ASHRAE 62.2 minimum calculated rate, as determined by the Diagnostic Workbook.
3. Installed whole-building ventilation operates continually or on an intermittent basis with a customer shut-off switch.
4. The customer signed a “refusal of ventilation” when ventilation was declined (DOE funds cannot be used for the job).
5. Ventilation Form filled out completely and left with customer.

Dryer Venting

1. Dryer venting is metal, not plastic, and newly installed venting is UL-listed.
2. Horizontal venting is secured every four feet.
3. Screws or other penetrations that will catch lint were not used to connect ducting.
4. A termination with a damper was used.
5. The vent system is not connected to any other appliance.
6. The damper has no screen to catch lint.

Electrical

1. Covers are present on all junction boxes and flagged if located in attics.
2. Live knob and tube wiring was not covered with installed insulation.

Asbestos

1. Documentation of asbestos safe work is provided as required.
2. Building and surfaces are free of any asbestos debris created by weatherization activities.

Lead

1. Documentation of lead safe work is provided.
2. Building and surfaces are free of any lead debris created by weatherization activities.

Moisture

1. Exposed soil floor is covered with ground vapor retarder. (If not covered, DOE funds cannot be used for the job).
2. Installed dehumidifier is ENERGY STAR and operable.

Radon

1. Sump covers installed.
2. Covers and penetrations are sealed.
3. Covers are moisture resistant.

Chapter 6: Repair

Repairs are defined as items necessary for the effective performance or preservation of installed weatherization materials. Repair measures are required to be reasonable, cost effective, and performed only when needed to install a measure necessary to effectively weatherize a building, along with written and photo documentation in the client's file. Examples include, but are not limited to, repairing minor roof leaks, electrical repairs, and fixing water leaks. Repairs may also include installing protective materials involved with weatherization measures, such as paint used to seal materials installed through weatherization.

Follow all applicable lead- and asbestos-safe work practices when performing repairs.

6.1 Windows and Doors

Windows and doors typically make up a small percentage of a building's thermal boundary. It is rare that enough heat loss occurs through them to justify cost-effective repair or replacement.

Experience from blower door testing has shown windows and doors tend not to harbor large air leaks. Though conductive and convective losses through windows and doors are often quite high on a per-square-foot basis, these losses are not affected much by most simple weatherization improvements.

Replacing missing and broken glass, re-glazing glass, installing sash locks, and installing weather-stripping is usually considered air sealing, not repair work (see *Air Sealing and Indoor Air Quality in Chapter 1 – Section 1.4*).

6.1.1 Window Repair and Replacement

Observe the following standards for window repair and replacement:

1. Seal around a replacement window on the exterior and interior to prevent water intrusion and air infiltration.
2. When replacing or installing new exterior trim or stop, prime all bare wood.
3. When replacing a broken pane of glass, size the replacement pane $\frac{1}{8}$ " to $\frac{3}{16}$ " smaller than the opening, to allow for movement of the frame.
4. Install tempered safety glass when the location requires it.

Replacing or Repairing a Basement Window

Determining whether to repair or replace windows located in an unintentionally conditioned basement is based upon customer use. Covering the entire window with plywood or other sheathing should only be considered when it is clear that the customer is agreeable to this option.

Before installing a new basement window, remove rotted framing and replace with pressure-treated lumber. Seal around framing to prevent water intrusion. Standard-size vinyl basement windows are a good choice for replacement when the customer requires an operable window, or cut a custom-sized piece of glass for the opening, allowing natural light to enter. Install a stop inside the framing as needed to place new window or glass against. A second piece of stop is used to hold the glass in place from the inside, creating a fixed-pane window.

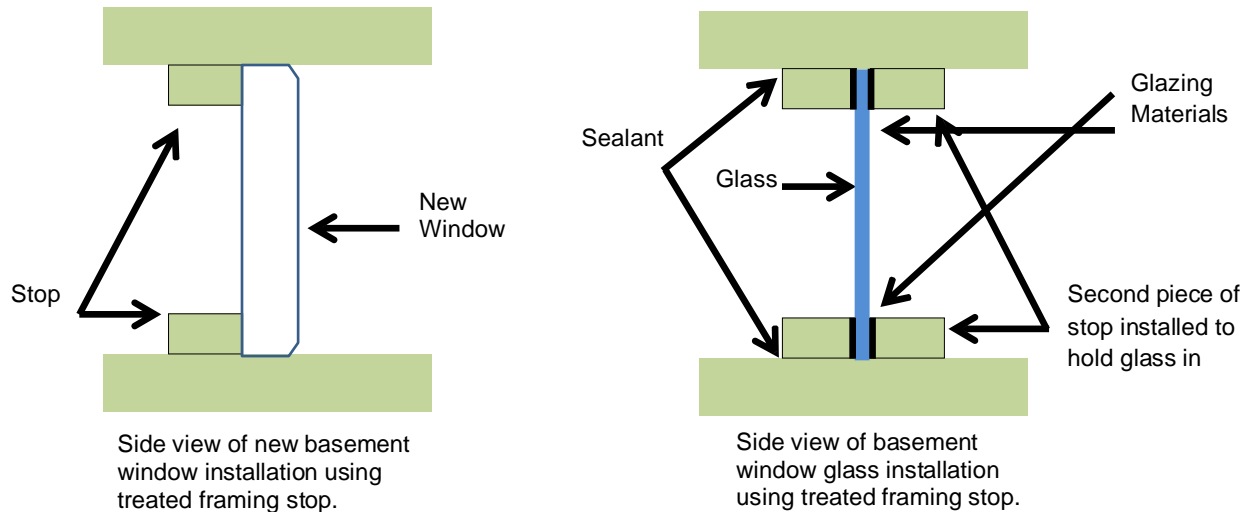

6.1.2 Door Repair and Replacement

Door operation affects building security and durability, so doors are often an important repair priority. Only primary doors may be replaced.

Door Repair

Door repair can also save energy if the existing door fits poorly. To improve the air seal of a door, limit door repair to the following work:

1. Replace missing or inoperable locksets. In some cases, a modernizer kit may be necessary.
2. Replace, install, or reposition the strike plate, as needed.
3. Replace, install, or reposition stops, as needed.
4. Replace deteriorated threshold.
5. Install a door shoe if needed to repair damage.

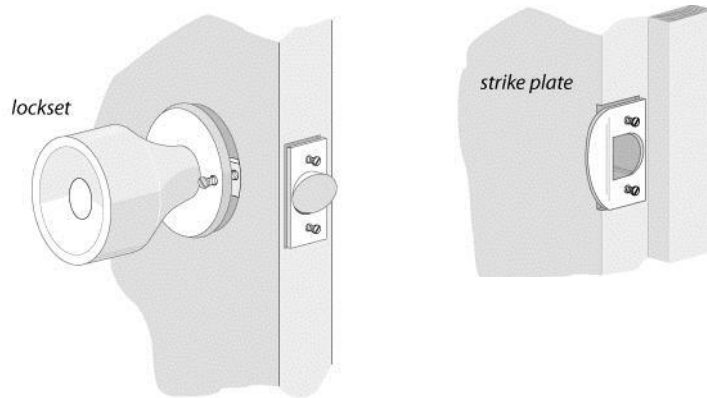

Minor door repair: Tightening and adjusting locksets, strike plates, and hinges helps doors work better and seal tighter.

Replacing a Primary Door

Follow these instructions when replacing a primary door:

1. Seal around the replacement door on the exterior and interior to prevent water intrusion and air infiltration.
2. If replacing or installing new exterior trim or stop, prime all bare wood.
3. After installation, confirm the door opens and closes smoothly, latches, and locks when shut.

Replacing or Fabricating a Basement Door

In older homes, basement exterior doors are often odd shapes and sizes. Sometimes, no door is present. If a door is present, it is sometimes in disrepair. Often weatherization installers fabricate a replacement door out of lumber — for air-sealing purposes, for security reasons, to preserve weatherization materials, or to maintain the integrity of the existing building materials.

Follow these instructions when fabricating a replacement basement door:

1. Use treated lumber.
2. Take precautions to reinforce the door, to prevent warping and to ensure longevity.
3. Seal around the replacement door framing on the exterior and interior to prevent water intrusion and air infiltration.
4. Insulating the fabricated basement door is optional. If insulated, insulation should be a minimum of R-5.
5. After installation, confirm the door opens and closes smoothly, latches, and locks when shut.

Final Inspection and Quality Assurance Standards

Acceptable installations shall meet the following standards.

General Repairs

1. The repairs are necessary for the effective installation, performance, and/or preservation of weatherization materials installed in the building.
2. The repairs are cost efficient and correct the problem(s) at hand.

Window Replacement

1. Window installation meets program instructions and the window unit is ENERGY STAR® certified.
2. The installed window opens smoothly and operates properly.
3. The installed window is installed square, plumb and true, as structurally allowable.
4. The installed window does not leak.
5. Installation meets all applicable best practices (e.g., flashed effectively, unit is back caulked, etc.)
6. Proper lead-safe work practices are documented in file.
7. The customer file contains photographs of the pre-existing window, and the photographs demonstrate the pre-existing window met the Wisconsin Weatherization Program guidelines for replacement.

Door Repair

1. All necessary door repairs were undertaken.

Door Replacement

1. The installed door opens and closes easily, latches tightly, and performs its function.
2. Replacement door meets R-value requirement.
3. Installation meets all applicable best practices (e.g., flashed effectively, back caulked, etc.).
4. Proper lead-safe work practices are documented in file.
5. The installed door does not leak.
6. The installed door is installed square, plumb and true, as structurally allowable.
7. The customer file contains photographs of the pre-existing door, and the photographs demonstrate the pre-existing door met the Wisconsin Weatherization Program guidelines for replacement.

Chapter 7: Manufactured Home Weatherization

7.1 Manufactured Home Weatherization

Manufactured homes, also known as mobile homes, present unique weatherization opportunities and challenges. Often, manufactured home weatherization practices differ from the practices for site-built dwellings. Manufactured homes typically use more energy per square foot than site-built homes, but their standard construction makes them more straightforward to weatherize. Insulation retrofits, air sealing, duct sealing, and replacement heating systems present some of the best energy-saving opportunities in manufactured homes.

Typical Components of a Manufactured Home:

- 1 – Steel chassis
- 2 – Steel outriggers and cross members
- 3 – Underbelly
- 4 – Fiberglass insulation
- 5 – Floor joists
- 6 – Heating/air conditioning duct
- 7 – Decking
- 8 – Floor covering
- 9 – Top plate
- 10 – Interior paneling
- 11 – Bottom plate
- 12 – Fiberglass insulation
- 13 – Metal siding
- 14 – Ceiling board
- 15 – Bowstring trusses
- 16 – Fiberglass insulation
- 17 – Vapor barrier
- 18 – Galvanized steel one-piece roof
- 19 – Metal windows

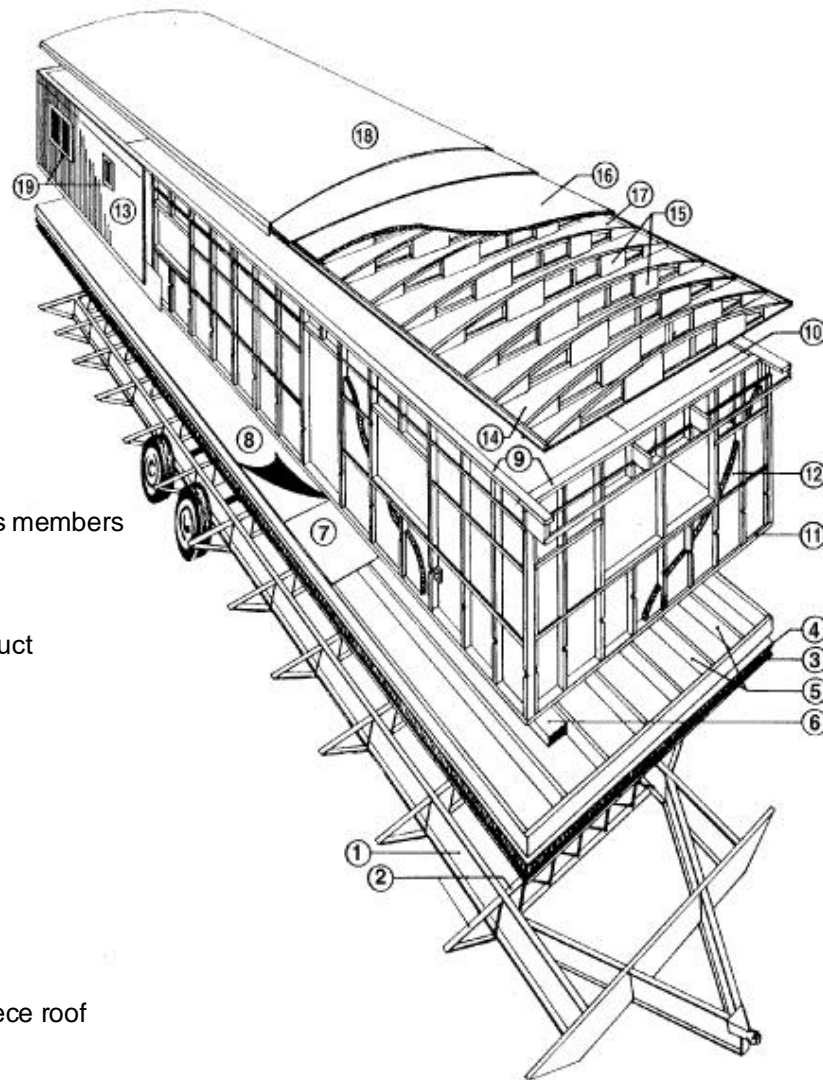

7.2 Supply Distribution System

Manufactured home supply ducts are usually outside the home's pressure boundary and often leak significantly, presenting an opportunity for savings through effective duct sealing. Sealing the ductwork should be completed prior to any repair work to the belly or insulating the belly cavity. Many leakage points in the system can be accessed from underneath the belly or from inside the home, see *Chapter 7 – Section 7.2.3*.

Visually inspect ducts and registers using a digital camera, borescope, or mirror and flashlight to identify large holes, gaps, or disconnected sections. Take photos by placing the camera (with the strap around the wrist) inside of the ductwork.

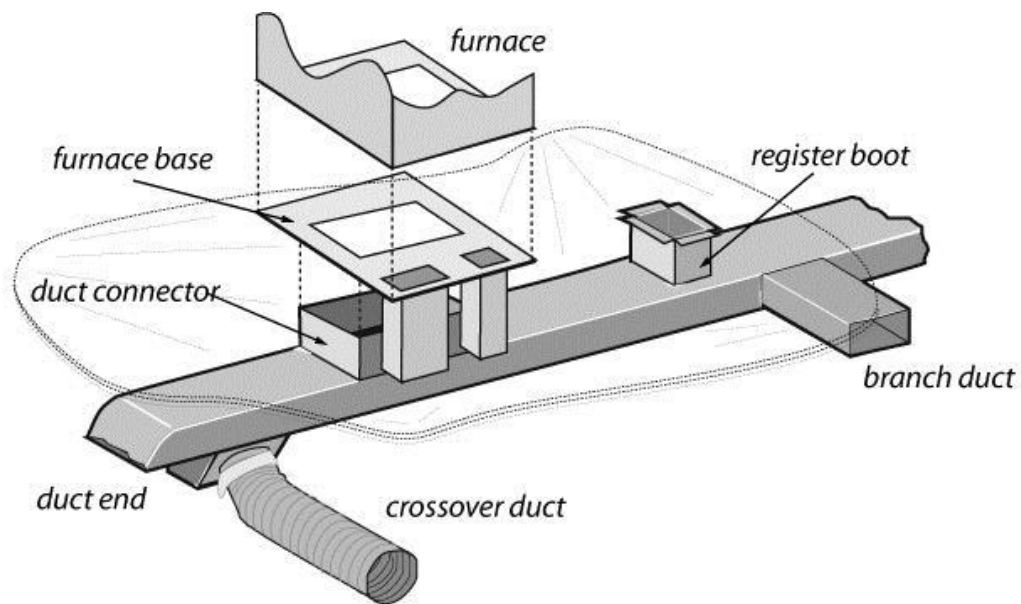

Manufactured home ducts: Manufactured home ducts leak at their ends and joints—especially at the joints beneath the furnace. The furnace base attaches the furnace to the duct connector. Leaks occur where the duct connector meets the main duct and where it meets the furnace. Branch ducts are rare, but easy to find because their supply registers are not in line with the others. Crossover ducts are found only in double-wide and triple-wide homes.

7.2.1 Pressure Pan Duct Testing

To measure the relative leakiness of the forced-air distribution system, complete the following steps:

1. Set up the manufactured home in winter condition, with all interior doors open and stationary.
2. Set the digital gauge to “PR/PR” and connect a pressure hose from a reference tap to outside. Measure the baseline House with respect to Outside (HwrtO) pressure. Turn on the blower door fan and adjust it to create a 50-pascal pressure difference HwrtO adjusted for baseline.

3. Without changing the blower door speed, disconnect the outdoor pressure hose from the digital gauge. Connect a pressure hose from an input tap to the pressure pan.
4. Go to the supply register located furthest from the furnace on one end of the manufactured home. Place the pressure pan over the register and record the pressure difference in the Diagnostic Workbook.
 - a. If the positioning of the register does not allow the pressure pan to form an airtight seal, other materials (duct mask and cardboard, etc.) may be used to create an airtight seal over the entire register. After developing an airtight seal, attach a metal pressure probe to the end of the hose. Puncture a small hole in the sealing material, insert the metal probe into the hole, and record the pressure difference.
5. Repeat Step 4 (4a) at all remaining registers in the home.

7.2.2 Interpreting Duct Leakage Results

When duct leakage exists, it allows air to infiltrate the ductwork; this infiltration causes the pressure difference as measured by the pressure pan between the supply ducts and the main body of the home. The more existing duct leakage, the greater the pressure difference between the ducts and the home's interior.

If ducts on one side of the home exhibit higher (less negative) pressures than ducts on the opposite side, substantial duct leakage exists in the general vicinity of those higher-pressure ducts, rather than at each duct individually. If such a discrepancy is observed at the ducts surrounding the furnace, this may indicate a need for duct sealing on the ductwork and connections near the furnace.

7.2.3 Manufactured Home Duct Sealing

If possible, seal supply ductwork located in the manufactured home belly so the cumulative pressure pan readings of all registers is 3 pascals or less, when the home is at 50 pascals with respect to outside. When duct sealing does not reduce the cumulative reading to 3 pascals or less, discontinue duct sealing and document the results in the Diagnostic Workbook.

The following locations are typically sealed from inside the manufactured home:

1. **Furnace to plenum connection when AC is not present:** Access this area by removing the A-coil access panel when no central air conditioning is present or gain access to this connection from underneath by cutting a hole in the road barrier under the heating system. Seal the road barrier after the duct sealing is completed.

Since the temperature at this location can be very high, it is recommended to use materials other than butyl tape, such as step-flashing cards, whenever possible. Butyl tape sags and loses its adhesive properties quickly at elevated temperatures.

For small to medium holes apply butyl tape and/or mesh tape and then apply a thick coat of mastic over both. To seal larger holes, attach sheet metal with fasteners taking care to seal the edges using mesh and mastic. Small holes and seams can be sealed with mesh

and mastic or mastic alone. Mesh is applied over all butyl tape, overlapping onto the ductwork to ensure a lasting seal.

2. **Register risers (collars) to floor and trunk:** Access this area by removing the floor registers or gain access to this connection from underneath by cutting a hole in the road barrier directly under the riser. Seal the road barrier after the duct sealing is completed.

Secure riser to trunk and/or floor before sealing connections. Large gaps can be covered with step-flashing cards. Be sure to sandwich mastic between the card and ductwork to obtain a permanent seal. Take care when sealing the riser to the top of the floor covering to allow the register enough room to seat correctly. Do not extend the tape beyond the lip of the register. As with all applications, butyl tape should be covered and overlapped with mesh tape and mastic, completely imbedding all exposed butyl tape, however, this may not always be possible at the top of risers.
3. **In-floor trunk lines:** Access this area by removing the floor register. Short pieces of pre-formed J-channel work well to hold collarless trunks tight to the floor before sealing with mastic. Trim channel as needed to ensure it is covered by the register.
4. **Trunk Termination:** The ends of trunk lines are often not sealed. Access this area by cutting into the road barrier directly at the end of the trunk. Seal the trunk termination by using butyl tape and overlapping with mesh tape and mastic. Seal the road barrier after the duct sealing is completed.

An optional method, when sealing the trunk termination is not possible, is to install a “scoop” or blocking after the last register. Ensure the scoop or blocking will not cause a pressure imbalance or reduce the air distribution at other registers. The scoop is constructed of sheet metal and is sealed to the duct walls, as per normal procedures. Ductwork is normally constructed to provide static pressure, which equalizes flow. When scoops are installed, they reduce the ability to create static pressure and the result is increased flow out of the scooped register. If the scoop is installed in ductwork in a room already getting adequate air flow, comfort and pressurization issues may arise.

Another option for blocking is to use the friction fit bag method. Push the bag as far back as possible from the last register and if access allows seal the bag in place with mastic.

The following locations are typically sealed from under the manufactured home. The road barrier (belly) may need to be cut open to gain access to the ductwork.

1. **Trunk to crossover duct on double-wide manufactured homes:** Generally constructed of insulated flex duct, the inner sleeve shall be mechanically secured and sealed to the starter collar of the main trunk. This is usually accomplished with strap ties or large diameter hose clamps. Sealing is generally performed with mastic. The outer sleeve is then secured to the trunk or the road barrier but does not need to be sealed.
2. **Plenum to trunk connections when central AC is present:** The trunk is opened directly below the furnace. It is recommended this piece be removed and replaced with an oversized piece of sheet metal either mechanically fastened to the inside or outside of the trunk. Placing the piece on the inside of the trunk ensures it will never sag or fall

out. As with all metal-to-metal connections, sandwich them with mastic. Sealing is performed in the same manner as Number 1 above.

3. **Take-offs from main trunk to side registers:** These connections can only be accessed from below the manufactured home. They are particularly leaky in ductboard trunk lines. Seal using the same materials and methods as used for collars and risers.
4. **Ends of trunk runs, abnormal leaks, anomalies, and any seams between sections:** The seams and other unusual leaks can be very difficult to locate. It is recommended the technician physically inspect all ducting whenever possible to find these leaks that may not otherwise be addressed. Seal as appropriate for the wide range of conditions that may be encountered.

7.3 Return-Air Distribution System

Many manufactured homes do not have ducted return systems; instead, the entire cavity or attic space is used as a return duct. Eliminate floor and ceiling cavities used as return-air plenums in favor of having return air flow through the hallway directly into the furnace.

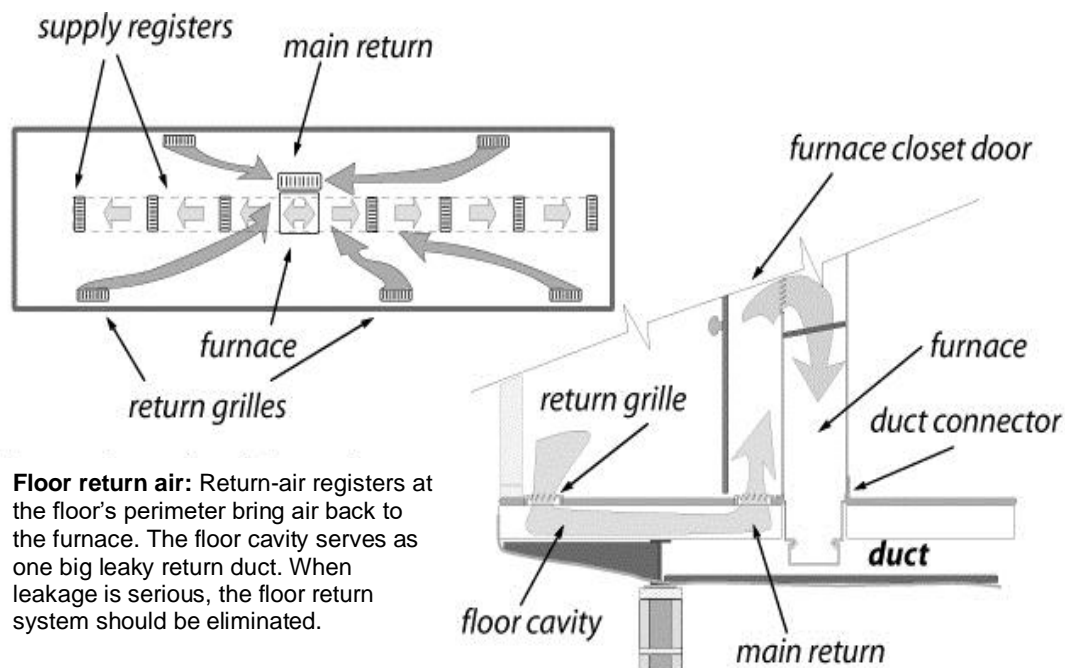

Floor return air: Return-air registers at the floor's perimeter bring air back to the furnace. The floor cavity serves as one big leaky return duct. When leakage is serious, the floor return system should be eliminated.

To eliminate a belly return-air system:

1. Block all floor return registers with a durable and tight air barrier, being careful to find hidden return registers under built-ins, behind furniture, and in kitchen cabinet kick-spaces.
2. In the furnace closet, block all floor duct openings completely. If the existing atmospheric furnace is retained, be careful not to seal its combustion air inlet.

3. Install grilles or a louvered door to provide furnace manufacturer's recommended net free return grille area in the furnace closet door.
4. Measure the temperature rise of the furnace to confirm air flow is within the manufacturer's instructions.

7.3.1 Measuring Temperature Rise

The heating system's temperature rise should be within the range specified on the manufacturer's label. If no manufacturer's information is available, ensure the furnace has sufficient air flow so the temperature rise is between 40° and 80°F.

To test the temperature rise of a manufactured-home heating system:

1. Inspect the plenum/furnace joint before measuring the temperature rise. Repair this joint, if needed, after completing testing.
2. Make sure all interior doors are open and stationary, except the furnace closet door.
3. Close the furnace closet door completely.
4. Turn on the furnace and allow the furnace to reach full steady-state conditions. Measure the supply temperature at the register closest to the furnace, making sure the air flow to this register is not blocked and no significant duct leakage exists between the furnace and the thermometer.
5. Subtract the house air temperature (the return air) from the supply air temperature. The difference is the temperature rise.

If the temperature rise is too high or too low, investigate for restrictions to air flow or remaining duct leakage. The fan speed may be adjusted to bring the temperature rise within the acceptable range.

7.3.2 Measuring Room Pressure Differences

When interior doors are closed while the heating system operates in a manufactured home, the supply air pressurizes the room and creates a pressure imbalance between the room and the main body of the home. This room-to-house pressure difference causes increased air exfiltration through that room's primary pressure boundary. Mitigating or eliminating the room-to-house pressure differences saves energy by reducing air leakage through the room's primary pressure boundary.

To measure individual room pressure differences:

1. Start/operate furnace air handler.
2. Measure the pressure difference across each interior door, one at a time. Place a hose inside the room away from the supply register and connect to the input tap of the digital gauge. Close the door, making sure the hose is not pinched or restricted. Record the room pressure with respect to house on the Diagnostic Workbook. If the room does not have a supply register, do not measure it.

3. Rooms with a measured pressure of greater than 3 pascals are excessively pressurized indicating the necessary path for return air is not present. A connection between the room and house can be achieved by the following:
 - a. Undercut the door (usually this is the most cost-effective option),
 - b. Install a grille in the door, or
 - c. Install a jumper duct under the floor.

After determining the size of the opening needed to lower pressurization, consult with the customer as to the best option for their situation. A simple method to determine the size of the opening needed to lower the pressurization in a room is to open the door slowly while measuring the pressure difference across the door until the pressure difference is 3 pascals or less. Measure the square inches of the opening created. This is the minimum net free area of room-to-house opening required to reduce the pressure difference to 3 pascals or less.

Example: *The door is opened by 2 inches, and the door is 80-inches tall. The net free opening to be added would be 160-square inches. Divide this area by the width of the door to determine how many inches need to be cut off the bottom of the door. An example would be $160/32$ or 5 inches. This is probably not going to be an acceptable solution (from a privacy standpoint). A door grille with 160 square inches of net-free area may be a better solution.*



7.4 Floor/Belly Insulation

Manufactured home existing floor cavities are usually insulated with wide fiberglass blankets attached to the bottom of the floor joists (typically 2 x 6 joists). Therefore, the entire cavity is uninsulated. In floors with transverse floor joists (following the width of the home), the duct is attached to the bottom of the floor joists, resulting in a dropped belly. This enlarged floor cavity can require an excessive amount of insulation, unless technicians can pin the belly material up to the floor joists to reduce the belly's volume. Average insulation densities for loose fill insulation installed in manufactured home bellies will be 1.25 to 1.75 pounds of blown fiberglass per cubic foot. **Do not dense-pack or over-fill this area.**

7.4.1 Preparations for Belly Insulation

Manufactured homes normally have a "road barrier" of fiberboard or tough fabric that protects the floor from rodents and road dirt during transport. Damage to this barrier is common and results in air leakage. Before installing belly insulation, follow these preparatory steps:

1. Confirm no water or sewer leaks are present. Confirm with customer if previous leaks or frozen pipes have occurred and document the locations. If leaks are discovered, contact the energy auditor or project supervisor for guidance on how to proceed.

2. Complete duct sealing (see *Return-Air Distribution System in Chapter 7 – Section 7.3*) and non-guideline air sealing around floor penetrations (see *Air Sealing in Chapter 7 – Section 7.7*) before installing floor insulation.
3. A vapor barrier may be used to provide a working surface for installers and ground moisture control. Remove the vapor barrier when site conditions may cause surface water under the manufactured home to pool on top of this barrier if leaving in place.
4. Secure water pipes up, as close to the floor joists as possible, so insulation will fill in beneath them. This ensures plumbing pipes are located on the interior (warm) side of the thermal boundary, to prevent frozen pipes. If this is not possible, insulate the pipes separately or insulate the belly underneath the pipes, leaving the space above the pipes uninsulated to allow ambient heat from the home to warm the pipes and prevent freezing.
5. With flexible dropped bellies, try to fasten the belly material to the floor joists in order to eliminate excess volume of the belly.
6. Repair holes in the belly, except those that provide convenient access for blowing insulation. Fasten belly patches with adhesive, clinch staples, or screws and lath strips, to provide durable patches. For large holes in road barriers, preferred patching materials include insulated sheathing board, fiberboard, and nylon reinforced mesh specifically manufactured for manufactured homes.

7.4.2 Insulating the Belly from Underneath

Blowing insulation into the belly with a large diameter fill tube from underneath is an effective and preferred installation method. The conditions and space restrictions underneath the manufactured home determine whether this option should be considered. A ground moisture barrier makes installing the insulation more comfortable for the installer. Insulation can be blown through existing holes in the road barrier before patching them. Installers should note where insulation has been installed and where it has not been installed. Some of the floor areas usually may only be accessible from underneath if they are to be filled at all.

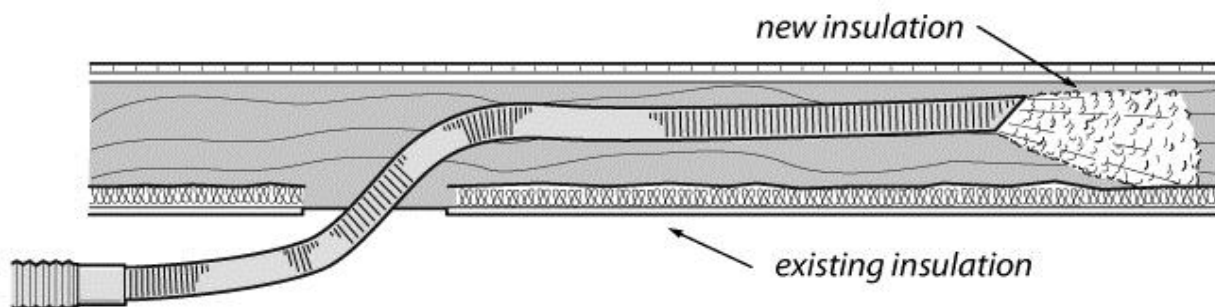

Blowing bellies: A flexible fill tube, which is significantly stiffer than the blower hose, blows fiberglass insulation through a hole in the belly from underneath the home.



Fill tube inserted into belly hole.



Blowing insulation from under the home:
A large diameter fill tube fills cavities rapidly from underneath.

7.4.3 Rim Blow through Rim Joists

Blowing insulation through the rim joist is another installation method. However, rim joists may not be drilled if they are determined to be a structural component of the foundation support system or if floor joists are 24 inches or greater on center. Drilling can be dangerous without a good drill and a sharp bit. To avoid weakening the door threshold, do not drill beneath doors. Do not drill directly through trim covering rim joist. Use wooden plugs to seal holes drilled in the rim joist. When possible, substitute the wing blow (see *Wing Blow in Chapter 7 – Section 7.4.4*) to avoid structural problems.

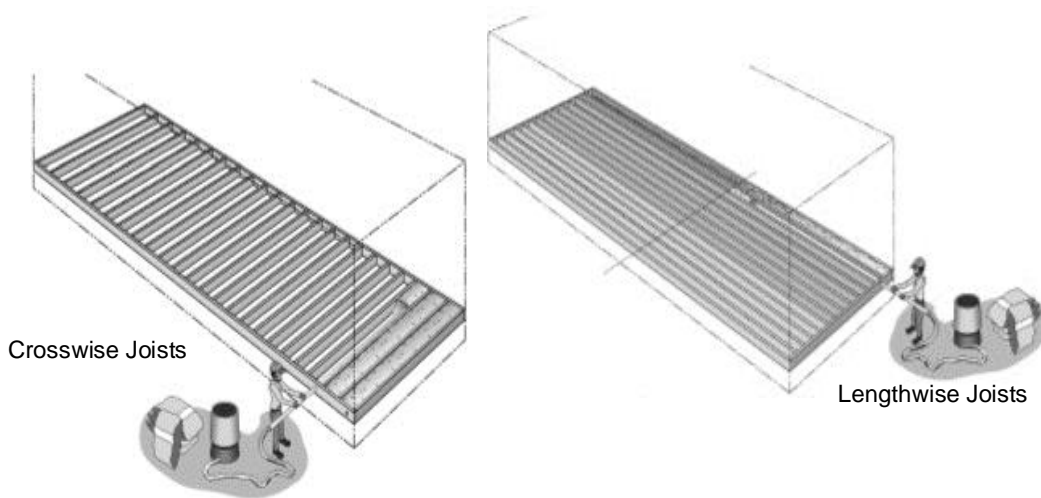

Insulating through the rim joist: Manufactured homes have either lengthwise or crosswise joists.

7.4.4 Wing Blow

Blowing insulation through the belly at the wing is a variation of the rim joist blowing technique. This method has some of the advantages of blowing from underneath and blowing through the rim joist. Specific areas, notably the floor cavity between the hole and the installer, need to be insulated using a shorter flexible fill tube. If bellies cannot be insulated through the rim joist and must be insulated from the wing or underneath, the use of a large diameter fill tube is preferred.

7.5 Attic/Ceiling Insulation

Fiberglass batts or blankets are usually present in the narrow roof cavity, but there is typically room for additional insulation. The space available typically varies from 1 or 2 inches along the building's edge, up to 10+ inches in the center for homes with bowstring trusses. Lightweight sloped-roof trusses provide up to 3 inches at the edge and up to 2 feet at the center. Crews may use a variety of methods to insulate manufactured home roof cavities, depending on the characteristics of the roof cavity, personal methodology preferences, and conditions on-site. Install insulation at uniform coverage and density between 1.25 and 1.75 pounds per cubic foot. Typically, it is more difficult to insulate the edges of the attic, so ensure insulation covers these areas.

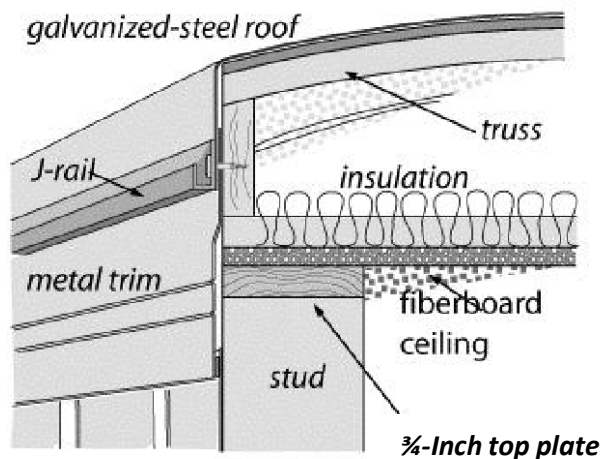

Bowstring roof details: Hundreds of thousands of older manufactured homes were constructed with these general construction details.

7.5.1 Preparing for Ceiling Insulation

Inspect the ceiling and roof to determine if conditions allow for adding insulation. It is important to perform repairs, as needed, to reinforce the ceiling.

Before installing ceiling insulation, follow these preparatory steps:

1. Hold insulation 3 inches back from recessed light fixtures, fan and heater housings, and chimneys not insulation contact (IC) rated. IC rated light and fan fixtures may have insulation surrounding them. Chimneys with zero-clearance thimbles can also contact insulation.
2. Complete air sealing around chimney bypasses above the heating system and water heater if present.
3. Inspect for ceiling openings in closets and cabinets and confirm insulation will not spill down through the ceiling into these areas.
4. Seal bypasses. If accessibility restrictions prevent air sealing, document the reason(s) in the customer file.

5. Mark the fill tube at 1-foot increments. If the edge is 7 feet from the hole, insert the fill tube to the 7-foot mark; if the fill tube does not go in far enough, try again.

7.5.2 Blowing the Roof Cavity from the Roof Blowing from a Square Hole

With customer approval cutting a 10-inch square hole directly over a truss gives access to two joist cavities and enough room to maneuver a 2-inch diameter fill tube. This large fill tube allows for a fast fill rate. The hole is stuffed with fiberglass batt to make it stand high. Patch the hole with a 14-inch square piece of stiff galvanized steel sheeting, sealed with roof cement and screwed to the roof with sheet-metal screws. Cover the patch with an 18-inch square piece of peel and seal butyl-aluminum roofing.

7.5.3 Blowing the Roof Cavity through Round Holes

Some technicians prefer drilling smaller holes to cutting the large square holes. This method requires using a smaller diameter fill tube to fill the roof cavity. The holes are filled with plastic plugs and sealed with silicone caulking. The plugs are covered with 6-inch-square patches of peel and seal. With this method, the holes are easier to patch. However, this system requires more holes in the roof.

7.5.4 Blowing a Pitched Roof

Pitched roofs are common in double-wide manufactured homes. More volume exists under these roofs than in a metal-roofed single-wide manufactured home. The density will be lower ($\leq 0.6\text{lb/ft}^3$) than when blowing the narrower, more airtight cavities and the cavity does not need to be completely filled to the peak. These roof cavities are often accessible through roof vents or the gable end.

In double-wide manufactured homes, adequate clearance may exist to insulate the ceiling cavity as an open blow. Access to the ceiling cavity can be gained through the gable end by removing the siding panels. Planking is usually necessary to distribute the weight of the installer and to make moving among the webbed trusses easier.

7.5.5 Blowing the Roof Cavity from the Edge

Metal roofs on manufactured homes are usually fastened only at the edge, where the roof joins the wall. When there is clear access along one long side of the home, this method can result in a fast and effective fill with minimum disturbance to the roof.

This procedure requires scaffolding in order to be performed safely and efficiently.

Carefully reseal the roof edge after insulating the cavity. The best way to refasten the roof edge is to



Roof-edge blowing: Use a rigid fill tube to blow insulation through the roof edge. This avoids making holes in the roof, though this process requires much care in refastening and resealing the roof edge.

seal it to the framing with new putty tape and staple it with an air-powered stapler, the way it was originally fastened. Also, seal the J-rail with putty tape, and re-screw it with larger sheet-metal screws.

7.5.6 Interior Drill and Blow

Drilling holes and blowing insulation into the roof cavity through a fill tube from the interior is a good procedure for inclement weather or when the exterior condition of the roof will not support other methods. The larger the hole, the easier it is to maneuver the tube out to the edge of the roof cavity. Use a plastic plug that matches the hole size. Use care not to damage the hole because the edge of the plug will not hide very much damage around the hole. If all of the holes are drilled in a straight-line, trim board may be installed to hide the drill holes.



Installing insulation through the ceiling: The technician pushes the fill tube into the cavity and out near the edge of the roof. The holes are drilled in a straight line for aesthetics.

7.6 Sidewall Insulation

The sidewalls of many manufactured homes are not completely filled with insulation. This reduces the R-value of the existing insulation because of convection currents and air leakage.

Before installing sidewall insulation, follow these steps:

1. Ensure the customer is aware of any pre-existing damage to the walls as well as the potential damage that can occur from insulating the walls.
2. With customer approval, remove pictures and wall hangings from the interior walls. Re-hang pictures and wall hangings after insulating the walls.
3. Add nails or screws to interior paneling and trim as necessary to reinforce interior walls.
4. Inspect the electrical system to determine if the wiring and circuit breakers or fuse box is adequate. Check the area around wall switches and outlets to determine if there is evidence of past electrical problems.



Checking walls: Measure the cavity and the existing insulation level. Make sure wall outlets work before and after insulation installation.

Do not insulate the walls if the wiring is in poor condition. If the wiring is poor in a specific area, contact the energy auditor or site supervisor for guidance on how to proceed. Document the conditions in the customer file.

If aluminum wiring is present, take the following precautions:

1. Mark cavities with outlet, switch, or light fixture on the outside siding. These cavities should be carefully tubed rather than stuffed with a batt, or, if excessive movement of the wires will still occur, then the cavity should not be insulated.
2. Test each outlet, switch, or light fixture to confirm that it is operating properly before insulating. Re-test afterward.

7.6.1 Preparing Siding for Wall Insulation

Metal siding on manufactured homes is typically installed vertically. Most metal-sided manufactured homes have horizontal rows of screws, which attach siding to horizontal 1 x 2 belt rails. Remove the bottom two rows when using the wall stuffing technique. To use the sidewall blowing technique, remove only the bottom row of screws. The metal siding joins piece-to-piece, with the first piece sliding inside a crimped channel in the second piece. It is better for this joint to remain together. Fastening a short sheet metal screw through the two sheets keeps them together during the insulation process.

Occasionally, manufactured-home siding is horizontal instead of vertical. To insulate these cavities, simply remove the bottom row of siding. Reinstall the siding when the insulation work is complete.



Loosening siding for wall insulation: Remove screws at the bottom of the metal siding. Before installing insulation, fasten the siding sheets together at the bottom with a short sheet-metal screw.

7.6.2 Sidewall Blowing Technique

Blowing insulation into manufactured-home sidewalls is similar to insulating sidewalls of site-built homes, although the fiberglass insulation is installed at a lower density. Take care not to create bulging walls during installation.

Insulate to the maximum structurally allowable. Insulate walls with complete coverage and uniform density throughout the accessible wall cavity. Insulating above windows is not required.

7.6.3 Sidewall Stuffing Technique

The best materials for this method are batts completely encased in breathable polyethylene film. Unfaced batts also work, when installed with a plastic sheet. The smooth plastic sheet allows the batt to slide up the wall against the interior paneling, without snagging or bunching. Some homes do not lend themselves to this technique because of obstructions in the walls.



Bowing walls: Using a fill tube works well for most mobile home wall cavities.

7.7 Air Sealing

See *Air Sealing in Chapter 1 – Section 1.4* for additional information.

7.8 Combustion Appliance and Fuel Distribution Safety

See *Combustion Appliance and Fuel Distribution Safety in Chapter 5 – Section 5.8* for additional information.

When the water-heater cabinet has an exterior door, best practice for completing depressurization testing is to insert testing probes via interior pathways. Run the hose through the exterior only when an interior pathway is not available.

When conducting gas leak detection, include gas piping under the manufactured home when accessible. Consider sampling ambient air for the percentage of LEL upon entry under the manufactured home.

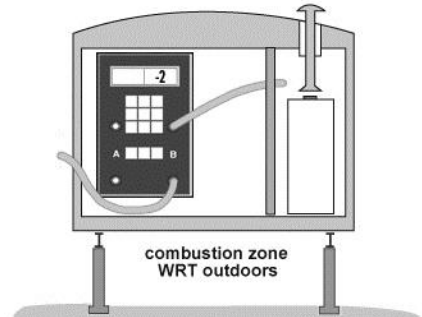

Water heater worst-case test:
Measure depressurization in the water heater closet from indoors if possible.

7.9 Heating Unit Replacement

Replacement furnaces shall be approved for use in manufactured homes. Follow current policy for the minimum Annual Fuel Utilization Efficiency (AFUE) rating. Replacement units should fit the footprint of the furnace closet and shall not stick out into the hallway.

Follow these steps when installing a new manufactured-home furnace:

1. Install properly sized units according to ACCA Manual J or an equivalent sizing formula by calculating the heating loads based on the post-retrofit dwelling characteristics. Include a copy of the sizing calculation in the customer file.
2. Properly remove and dispose of existing unit.
3. Install a new furnace base, unless the existing base matches the new furnace.
4. Support the main duct underneath the furnace with additional strapping, if necessary, to hold it firmly in place.
5. Attach the furnace base firmly to the duct connector. Seal all seams between the base, the duct connector, and main duct with mastic and fabric tape.
6. Carefully seal the base plate to the floor, in order to prevent air leakage through the belly and floor.
7. Provide a complete air seal and weather seal around the new chimney and combustion air pipe where it penetrates the roof, ceiling, wall, and/or floor.
8. Provide a complete water-tight weather seal at the roof penetration. Reinforce the area underneath the roofing with plywood or other strong material if necessary, to create a strong patch and to prevent a low spot in the roof at the penetration. It is best for any roof patch to be slightly elevated from the surrounding roof, to prevent water collection at

the patch.

9. Conduct a combustion test and confirm the test results meet manufacturer's instructions.
10. Install a condensate pump, if necessary, to convey the furnace's condensate to an approved sanitary drain per code. See *Condensate Removal in Chapter 3 – Section 3.8.2*.
11. Use existing distribution system and gas supply line.
12. Provide an owner's manual with heating system replacements.

See *Heating System Measures in Chapter 3* for more information.



Condensate pumps: These small pumps install in the furnace cabinet.

7.10 Water Heater Replacement

Replacement water heaters shall be approved for use in manufactured homes. See *Water Heater Replacement in Chapter 4 – Section 4.1* for additional information.

7.10.1 Gas Water Heater Installations

The following standards are specific to gas water heater replacements:

1. Measure and adjust gas pressure to follow manufacturer's instructions.
2. Follow manufacturer's venting instructions along with the International Fuel Gas Code to establish a proper venting system.
3. Seal the combustion air sleeve where it meets the water heater tank, using an approved sealant, to reduce the likelihood of back drafting.
4. Confirm the combustion air sleeve is properly sealed and drawing air from outside of the water heater CAZ.
5. Follow manufacturer's instructions to establish a proper combustion air system.
6. Verify there are no gas leaks in any of the supply piping.
7. Confirm the presence of a proper sediment trap on the gas line.
8. Test for carbon monoxide.
9. Remove and properly dispose of existing water heater.

7.10.2 Exterior Access Water Heater Closets

Follow these steps when addressing exterior access water heater closet:

1. Insulate water heater closet at the exterior closet door and associated wall area. Cover air vents if they are present and route combustion air (for gas units) from underneath the belly or through skirting.

2. Seal the common wall between the living area and water heater.
3. Ensure water heater is properly drafting after completing the work.
4. Insulate all water pipes to prevent freeze-up problems.

7.11 Repair

See *Repair in Chapter 6* for more information.

7.12 Window Replacement

See *Repair in Chapter 6 – Section 6.1.1* for more information.

7.13 Interior Storm Windows

Interior storm windows double the R-value of a single-pane window and reduce air leakage, especially in the case of leaky jalousie prime windows. Install interior storm windows on primary single-pane windows that currently have no storm window when selected by the Manufactured Home Energy Audit for replacement as a measure or listed as a repair. The following types of storm windows can be installed:

- Install stationary, removable interior storms with awning- and jalousie-style windows.
- Install sliding interior storm windows to match exterior sliding prime windows. Make sure the movable sash of the storm window is on the same side as the primary window for horizontal sliders.

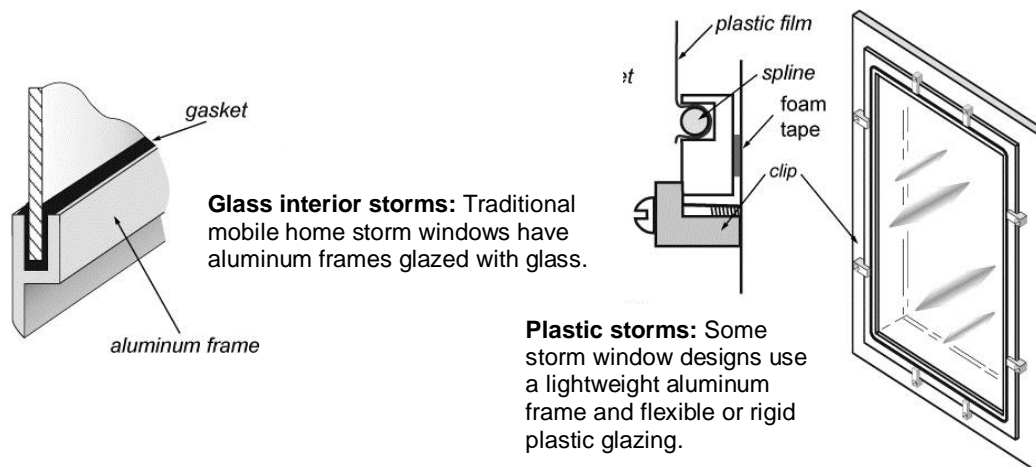

7.14 Door Replacement

Install minimum R-5 or standard manufactured home replacement doors when listed on MHEA as a repair. Manufactured home doors come in two basic types: metal manufactured home doors and more typical wood-frame residential doors (as in stick-built homes). Manufactured home doors swing toward the outdoors and are usually not standard heights. House-type doors usually swing toward the interior of the home. If the existing door is a conventional door, See *Repair in Chapter 6 – Section 6.1.2*.

To replace a metal manufactured home door, follow these steps:

1. Measure the existing door and frame *before removing them* to ensure the replacement door is sized appropriately.
2. Exercise care and caution if removing the existing door trim, to enable trim to be re-attached after the new door is installed.
3. Remove and properly dispose of the old door — do not leave it on-site.
4. Install the new door frame plumb and level, using shims as necessary. Detaching the door from the doorframe first may make it easier to work with the doorframe.
5. Seal the space between the rough framing and the door frame. If spray foam is used for air sealing, use minimal expansion foam, since excessive foam expansion can force the door out of level or plumb.
6. Caulk around the door and frame as necessary to prevent water intrusion.
7. Confirm the new door opens, closes, latches, and locks properly.
8. Reattach the door trim.
9. If necessary, install a J-type channel above the door to direct rainwater away from the entry.

Final Inspection and Quality Assurance Standards

Acceptable installations shall meet the following standards.

General Instructions

1. All work follows the regulations of all authorities having jurisdiction.
2. All materials are installed to manufacturer instructions.
3. All debris is removed from the job site and properly disposed, recycled, or delivered to a licensed hazardous waste facility.
4. All applicable building permits were attained.
5. When applicable, all materials must be approved for use in manufactured homes.

Heating Systems (See *Chapter 3* for general standards)

1. Heating system is approved for manufactured homes.
2. Thermostat is located on an interior wall.

Distribution Systems

1. Manufactured home return air system is centralized through living space.
2. Sheet metal with fasteners or a friction fit bag appropriately sealed was used to block supply ends extending beyond the last register.
3. Sheet metal with fasteners was used to block large holes in the distribution system.
4. Sealing material is not failing.
5. Total measured pressure of supply registers in a manufactured home is < 3 pascals when $H_{wrtO} = 50$ pascals, unless sealing activity and documentation shows it is not cost effective to continue.
6. Room pressures are < 3 pascals when the air handler is operating.

General Repairs

1. The repairs are necessary for the effective installation, performance, and/or preservation of the weatherization materials installed in the building.
2. The repairs are cost efficient and still correct the problem(s) at hand.

Glass Replacement

1. Glass is the correct type for the installation (e.g., tempered glass is required in doors and sidelights, within 6 feet of tubs, and for all windows less than 18 inches off of the ground or floor level; obscure glass may be required in bathrooms).

Window Replacement

1. Window installation meets program instructions and is ENERGY STAR® certified.
2. The new window opens smoothly and operates properly.
3. The new window is installed squarely, as structurally allowable.
4. The new window does not leak.
5. Installation meets all applicable best practices (e.g., drain planes, back caulked, etc.).
6. Proper lead-safe work practices are documented in file.
7. The customer file contains photographs of the pre-existing window, demonstrating unit met Wisconsin Weatherization Program protocols for replacement.

Door Replacement

1. The new door opens and closes easily, latches tightly, and performs its function.
2. Replacement door meets R-value requirement.
3. Installation meets all applicable best practices (e.g., drain planes, back caulked, etc.).
4. Proper lead-safe work practices are documented in file.
5. The replacement door does not leak.
6. The replacement door is installed squarely, as structurally allowable.
7. The customer file contains photographs of the pre-existing door, demonstrating unit met Wisconsin Weatherization Program protocols for replacement.

APPENDICES

A-1: Glossary	A-2
A-2: R-Values for Common Materials	A-7
A-3: Insulation Density and Bag Count Calculations	A-8
A-4: General Information on Spray Polyurethane Foam (SPF)	A-13

A-1: Glossary

ACH: air changes per hour, an estimate of building ventilation or air leakage rates.

ACH₅₀: air changes per hour at 50 pascals, a measurement of a building's air leakage rate, as determined with a blower door.

ACH_{nat}: air changes per hour (natural), an estimate of building ventilation or air leakage rates under normal operating conditions.

Add-A-Hole Method: A zone pressure diagnostic test to measure/estimate serial leakage, involving adding a hole of known size to one side of the series leakage path and measuring the pressure differential before and after adding the hole.

AFUE: Annual Fuel Utilization Efficiency, the seasonal efficiency of a space heating system. It is expressed as the percentage of useful energy delivered to a building, as impacted by long-term weather conditions, compared to the amount of energy consumed.

AGA: American Gas Association, an organization that provides standards for gas appliances and fuel systems.

Appliance: Any device (refrigerator, freezer, etc.) powered by electricity designed for household use. May be replaced as an ECM as approved by the Division.

ASHRAE: American Society of Heating, Refrigeration, and Air Conditioning Engineers, an organization that provides standards for a wide variety of space conditioning and ventilation work.

Base load measures: Energy conservation measures that reduce any energy use of the dwelling unit that is not driven by weather. Base load ECMs may include water heater replacement, LED lamp replacement, or refrigerator and freezer replacement.

Basement: The substructure of a building, with the exterior walls forming the building foundation. Most of the basement is usually below ground. Wall heights vary but are usually higher than 70 inches. In Wisconsin, the basement is often the combustion appliance zone. If the basement is unintentionally heated by ducts or pipes, the work done on the basement is sealing and insulating the box sill and sealing any large opening in the exterior walls. If the basement is intentionally heated, the walls may be insulated on the exterior, based on how much is above grade exposure and the results of modeling the building with the NEAT audit. See *Chapter 2 – Section 2.5 Floor and Foundation Insulation* for more information on treatments.

Blower door: a system used to measure air leakage through a building shell, using a calibrated fan coupled with a pressure gauge.

BTU: British Thermal Unit, an SI unit of heat energy.

BTU/hr: BTUs per hour, a measurement of an HVAC system's capacity to consume fuel or deliver space conditioning energy.

CAZ: Combustion appliance zone.

CFL: Compact fluorescent lamp.

CFM: Cubic feet per minute, a measurement of air flow (as through a furnace air handler or a blower door).

CFM₅₀: Cubic feet per minute at 50 pascals, a common standardized measurement of air leakage, as determined using a blower door.

CO: Carbon monoxide, a colorless, tasteless, odorless gas that is poisonous, even in very low concentrations. It is commonly the result of incomplete combustion of a fuel.

CO₂: Carbon Dioxide, a colorless, tasteless, odorless gas that interferes with thinking and alertness when present in moderate concentrations and is poisonous in high concentrations.

Combustion appliance zone (CAZ): The area where vented combustion appliances are located. The zone can be located inside or outside the pressure boundary.

Comfort sealing: Air sealing work with the primary purpose of controlling drafts, commonly performed with advice from the dwelling unit's occupant. Comfort sealing is performed when blower door testing cannot be performed. When blower door testing cannot be performed, sealing work is limited to attic bypass and key juncture sealing, glass replacement, and up to one work hour of comfort sealing.

Completed measure: A measure installed in accordance with all standards and specifications in program policy.

Completed unit: A dwelling unit that has received all the appropriate weatherization measures required by the measures list or computerized audit and has passed a final inspection.

Computerized audit system: The energy audit approved by the Division for use on 1- to 4- unit buildings and mobile homes.

Conditioned: An area or space heated or cooled by a heating or cooling system controlled to maintain habitable temperatures (as by a thermostat).

Crawl space: An unfinished space under the floor of a building. The exterior walls are usually no higher than 40 to 50 inches. Most crawl spaces have dirt floors. Access hatches sometimes are in the basement through a common wall or in an outside foundation wall. This area often contains plumbing, wiring, and ductwork. Access to this space is usually limited to servicing the plumbing, wiring, or ductwork. The decision on where to insulate in a crawl space depends on if plumbing or ductwork runs through the space. If it does, usually the outside walls and box sill are sealed and insulated using rigid insulation, fiberglass batts, or two-part foam, rated for the application. In unheated crawl spaces, without ducts and pipes, the box sill and floor of the building are sealed and insulated, often with blown cellulose or fiberglass batts. A continuous moisture barrier must be installed if the crawl space has a dirt floor. See *Chapter 2 – Section 2.5 Floor and Foundation Insulation* for more information on treatments.

CRF: Cannot Reach Fifty, blower door procedure when 50 pascals of pressure cannot be reached.

Damaged materials: Materials specifically assigned or designated for a specific dwelling unit/job and are damaged and made unusable either during transit to the job site or at the job site.

DOE: Department of Energy.

Energy audit: An inspection of the dwelling unit documenting its conditions from a thermal, structural, appliance, lighting, and safety perspective. This may be based on Required Measures List or the Division-approved software program that generates a list of recommended weatherization measures for the dwelling unit, according to the software program's specifications.

Energy conservation measures (ECMs): The measures installed in a home that return energy cost savings. ECM measures are in contrast with Health and Safety and Repair measures that do not return an energy cost savings benefit.

ENERGY STAR®: An EPA/DOE program providing incentives for manufacturers to make energy-efficient products and encouraging consumers to buy these products.

EPA: Environmental Protection Agency.

Final inspection: The inspection performed on a dwelling unit by a non-crew member. The final inspection follows the completion of on-site work. The final inspection must be performed before the owner can sign off.

Friable asbestos: Any asbestos-containing product that can be crumbled, pulverized, or reduced to powder by hand pressure.

GDA: Greatest depressurization achievable.

GFCI: Ground-fault circuit interrupter.

Guideline sealing: Air sealing work completed using the Weatherization Cost-Effective Sealing Guidelines including sealing work between the house and the outside. This work often addresses air leakage sealing near the neutral pressure plane.

Heating costs: Costs of any source of heating in a dwelling unit used for residential heating purposes. All heating costs for commercial, business or any purpose other than the dwelling unit of the applicant are excluded.

Home energy: All fuel sources used in a dwelling unit. It includes all heating costs and non-heating costs. Non-heating costs are often referred to on utility bills as base load costs (the base costs before heating costs are included).

HVAC: Heating, ventilation, and air conditioning.

IFGC: International Fuel Gas Code.

Infiltration: The uncontrolled air entering the building, usually at the lower portion of the building.

Intentionally conditioned: An area or space intended to be heated or cooled by a heating or cooling system, usually to the level controlled by a thermostat in the space.

IWC: Inches of water column.

Key junctures: Junctions between building components which require careful sealing and/or insulating (e.g., wall-floor junctions).

kW: Kilowatt, a measurement of electrical power.

kWh: Kilowatt hour, a measurement of electrical use.

Lead-based paint: Paint with a lead content of not less than 0.06% by weight or 0.7 milligrams per square centimeter of painted area.

Lead-safe working conditions: Conditions that meet the OSHA and EPA requirements for adequate protection from lead exposure for both the building occupants and the workers performing the weatherization activities.

LED lamp: Light-emitting diode light bulb.

Make-up air: Air ducted into a home intentionally to make up for air being exhausted out of the home by exhaust fans or chimneys.

Manual J: The ASHRAE-approved method for calculating building heat loss and estimating the correct capacity for space conditioning systems to be installed.

MHEA: Manufactured Home Energy Audit, energy audit software by DOE for evaluating and prioritizing weatherization work in manufactured housing.

NEAT: National Energy Audit Tool, energy audit software by DOE for evaluating and prioritizing weatherization work in site-built housing.

Non-guideline sealing: Major air sealing work needed prior to other shell measure activities to control gross air leakage and protect the building from deterioration caused by air and moisture migration.

NFPA: National Fire Protection Association, an organization that establishes standards for materials and systems that affect building fire safety.

OSHA: Occupational Safety and Health Administration, the agency that establishes rules and regulations to promote worker safety and health.

Pa: Pascal, the metric unit of pressure.

ppm: Parts per million, a measure of concentration of one material dissolved in another (as in CO contaminating breathing air).

Pressure boundary: The various materials and components that make up the air barrier of a home.

psi: Pounds per square inch, the SI unit for measurement of pressure.

PVC: Polyvinyl chloride, material used in PVC pipe and plastic sheeting.

Radon: A colorless, odorless radioactive gas that occurs naturally that has been shown to cause health issues.

SDS: Safety data sheet, describing the hazards of a material and treatment for exposures to the material.

SEER: Seasonal energy efficiency ratio, a measurement of air conditioning efficiency, as impacted by long-term weather conditions.

Short basement: A cross between a crawl space and a basement. Short basements often have

dirt floors and are accessed through doors in the floor or from the exterior of the building. The exterior walls are usually higher than 40 inches but shorter than 78 inches and may vary if the floor is not level. This space often contains the building's heating and water heating equipment. Rarely used on a day-to-day basis, they are often only accessed to service the equipment. If a short basement is unintentionally heated by ducts or pipes, the work done in the space is focused on sealing and insulating the box sill and sealing any large openings in the exterior walls. If a short basement is intentionally heated, the walls may be insulated on the exterior, depending on how much wall is exposed above grade, and based on the results of modeling the building with the NEAT audit. The decision on installing a ground vapor retarder should be made based on the site conditions. See *Chapter 2 – Section 2.5 Floor and Foundation Insulation* for more information.

Sone: Measurement of noise used in rating exhaust fans.

SSE: Steady-state efficiency, expressed as a percentage; a ratio of the amount of useful energy delivered to a building compared to the amount of fuel consumed.

Sump Pit: A water collection hole, (also known as sump, sump basin, or sump well) located below the normal grade of a building's drainage system. Typically found in the basement of a house.

Sump Pump: A pump designed to empty water from a sump pit.

TESP: Total External Static Pressure, a measurement of resistance to air flow in furnace duct systems.

UDC: Wisconsin uniform dwelling code.

Ventilation: The intentional exchange of indoor air with outdoor air to remove pollutants, especially moisture.

Venting: The system of flues, vent connector, and chimney that exhausts combustion gases out of the home.

wrt: With reference to; used to describe the configuration of the digital gauge set-up during blower door testing.

A-2: R-Values for Common Materials

Material	R-value
Fiberglass or rock wool batts and blown 1"	2.8–4.0
Blown cellulose 1"	3.0–4.0
Vermiculite loose fill 1"	2.7
Perlite 1"	2.4
White expanded polystyrene foam (beadboard) 1"	3.9–4.3
Polyurethane/polyisocyanurate foam 1"	6.2–7.0
Extruded polystyrene 1"	5.0
Sprayed 2-part polyurethane foam 1"	5.8–6.6
Icynene foam 1"	3.6
Oriented strand board (OSB) or plywood 1/2"	1.6
Concrete or stucco 1"	0.1
Wood 1"	1.0
Carpet/pad 1/2"	2.0
Wood siding 3/8–3/4"	0.6–1.0
Concrete block 8"	1.1
Asphalt shingles	0.44
Fired clay bricks 1"	0.1–0.4
Gypsum or plasterboard 1/2"	0.4
Single pane glass 1/8"	0.9
Low-e insulated glass (Varies according to Solar Heat Gain Coefficient (SHGC) rating.)	3.3–4.2
Triple glazed glass with 2 low-e coatings	8.3

Attic Insulation – Calculating Density

Step 1 – Calculate volume of installed insulation: Multiply area times the depth of the attic insulation to get the volume of insulation.

$$1500 \text{ SQ FT} \times 6.4/12 \text{ FT} = 800 \text{ CU FT}$$

Area Depth in Inches Inches per Foot Volume of Insulation

Step 2 – Calculate the weight of insulation installed: Take the number of bags times the weight per bag to get the total weight.

$$52 \text{ BAGS} \times 24 \text{ LBS/BAG} = 1248 \text{ LBS}$$

Number of Bags Weight of a Bag Installed Weight

Step 3 – Calculate the density of installed insulation: Divide pounds of insulation by cubic feet of insulation volume to get the density.

$$1248 \text{ LBS} \div 800 \text{ CU FT} = 1.56 \text{ LBS/CU FT}$$

Pounds of Insulation Insulation Volume Installed Density

Note: Density should be between 1.3 and 2.0 pounds per cubic foot or conform to the manufacturer's instructions for density, coverage, and bag count for the desired R-value.

Wall Insulation – Calculating Numbers of Bags

Step 1 – Calculate the perimeter of a house: If the house is a simple rectangle or near a simple rectangle, use the formula below. If the house has numerous unequal sides, simply add the lengths together to find the perimeter.

$$(2 \times 50 \text{ FT}) + (2 \times 30 \text{ FT}) = 160 \text{ FT}$$

Length
Width
Perimeter of House

Step 2 – Calculate the total wall area: After calculating the perimeter of the house, multiply it times the wall height. This will give the total wall area.

$$160 \text{ FT} \times 8 \text{ FT} = 1280 \text{ SQ FT}$$

Perimeter of House
Height of Wall
Total Wall Area

Step 3 – Calculate the net wall area: Calculate the sum of the areas of the windows and doors. Subtract them from the total wall area to get the net wall area.

$$1280 \text{ SQ FT} - 150 \text{ SQ FT} = 1130 \text{ SQ FT}$$

Total Wall Area
Area of Windows and Doors
Net Wall Area

Wall Insulation – Calculating Number of Bags (Continued)

Step 4 – Calculating bag count: Multiply the net wall area by 1.1 to 1.5 pounds per square foot for a 2 x 4 wall. Then divide the number of pounds per bag to get the bag count.

$$\frac{1130 \text{ SQ FT} \times 1.2 \text{ LBS/SQ FT}}{24 \text{ LB PER BAG}} = 57 \text{ BAGS}$$

Net Wall Area

Weight of a Bag

Pounds per Sq. Ft. (based on)

Bags of Insulation Needed

Wall Insulation – Calculating Density

Step 1 – Calculate the wall volume: Multiply the wall's surface area times the depth of the wall cavity converted to feet.

$$57 \text{ BAGS} \times 24 \text{ LBS/BAG} = 1368 \text{ LBS}$$

Bags Installed
Weight of a Bag
Pounds of Insulation

Step 2 – Calculate the weight of the insulation: Multiply the number of bags installed times the weight of a single bag to get the weight of the installed insulation.

$$1280 \text{ SQ FT} \times 3.5/12 \text{ FT} = 373 \text{ CU FT}$$

Net Wall Area
Inches of Wall Depth
Inches per Foot
Wall Volume

Step 3 – Calculate the density of the installed insulation: Divide the pounds of insulation by the cubic feet of insulation volume to calculate the density.

$$1388 \text{ LBS} \div 373 \text{ CU FT} = 3.67 \text{ LBS/CU FT}$$

Pounds of Insulation
Insulation Volume
Installed Density

A-4: General Information on Spray Polyurethane Foam (SPF)

Low-Pressure SPF

Low-pressure SPF systems are two-component polyurethane foam products. They are typically delivered to the job site in pressurized canisters (~250 psi), dispensed through unheated hoses through a disposable mixing nozzle system, and applied as a froth-like material to substrate. This type of SPF product is typically used for air sealing and small-scale insulation projects and most commonly come in 200 or 600 board foot disposable kits.

High-Pressure SPF

High-pressure SPF systems are two-component polyurethane foam product. They are typically delivered to the job site in unpressurized drums or totes and dispensed by a proportioner pump where heat and pressure are added. These chemicals travel through heated hoses to a spray gun where the material mixes and is aerosolized during application. This type of SPF product is typically used for larger insulation applications.

Once installed, there is essentially no difference in product performance between low- and high-pressure foams. It should be noted that the main differences between the two types of systems are the application rate, PPE requirements, airborne concentrations of chemicals during application, and capital equipment investment.

Applicators should obtain training from the suppliers of SPF to help ensure installation quality, proper use of all equipment, and safe handling and disposal of all chemicals used in the process. Spray Polyurethane Foam Alliance (SPFA) also offers additional resources for low- and high-pressure SPF products.

Safety and Application

During application of SPF products, chemicals are released into the air during the mixing of the chemicals. Chemical fumes can be inhaled, and chemical dust can be absorbed through the skin making proper ventilation and appropriate PPE critical in preventing exposure to the applicator. Exposure to SPF chemicals can occur even at low exposure levels. Customers should be informed about the use of SPF products in their home, and installers should be well-informed about the procedures used to keep them safe. Employers must ensure compliance with OSHA's hazard communication requirements. Customer's belongings must be protected from overspray during use, and the substrate that the foam is being applied to must be free of excessive dirt as the foam will expand in all directions. If the area is not properly prepared prior to application, the foam may not adhere or can pull away from the surface.

Manufacturer Installation Instructions

SPF applicators should follow all manufacturer installation instructions for the product being used. These instructions include product-specific documents such as application instructions, Safety Data Sheets (SDS), and evaluation reports.